

KOMATSU

D155AX-8

EU Stage IV Engine

CRAWLER DOZER

D155AX



ENGINE POWER

268 kW / 360 HP @ 1.900 rpm

OPERATING WEIGHT

41.690 kg

BLADE CAPACITY

SIGMADOZER® 9,4 m³

Semi-U blade 9,4 m³

U blade 11,9 m³

Walk-Around

D155AX-8



ENGINE POWER

268 kW / 360 HP @ 1.900 rpm

OPERATING WEIGHT

41.690 kg

BLADE CAPACITY

SIGMADOZER® 9,4 m³
Semi-U blade 9,4 m³
U blade 11,9 m³



OUTSTANDING PRODUCTIVITY & FUEL ECONOMY

Powerful and Environmentally Friendly

- Low consumption EU Stage IV engine
- Unique torque converter with auto lock-up
- Adjustable auto idle shutdown
- Hydrostatic cooling fan with cleaning mode

Optimised Work Equipment

- Highly efficient Sigmadozer® blade
- Dual tilt blades with hydraulic pitch
- Automatic blade pitch and ripper return

First-Class Operator Comfort

- Quiet and comfortable cab
- Fully adjustable air-suspended seat
- Integrated rear-view camera

State-of-the-Art Controls

- Hydrostatic steering system
- Gearshift preset function
- Palm Command Control System (PCCS)
- Large multifunctional monitor with troubleshooting function

Tough and Reliable

- Low-drive undercarriage
- Sturdy, rugged design
- K-Bogie undercarriage system
- Extra long life "PLUS" undercarriage (option)

KOMTRAX

- Komatsu Wireless Monitoring System
- 3G mobile communications
- Integrated communication antenna
- Increased operational data and fuel savings



A maintenance program
for Komatsu customers

Powerful and Environmentally Friendly



Automatic transmission

Set by default, the D155AX-8 has a highly efficient transmission that automatically matches the best gear mode in all dozing operations and includes a travel speed preset function to reduce work time and fatigue for the operator. With Komatsu's ECMV (Electronic Controlled Modulation Valves) gear changes are smoothly timed to always keep the power transfer at maximum efficiency.

Torque converter with auto lock-up

Combined with the automatic transmission, the exclusive Komatsu automatic lock-up torque converter reduces fuel consumption by up to 10% by eliminating unnecessary power loss. When required, the powertrain control system engages the torque converter, or locks it up to send full engine power directly to the transmission during less torque demanding applications.

Adjustable idle shutdown

To reduce unnecessary fuel consumption and exhaust emissions, and for lower operating costs, the Komatsu auto idle shutdown automatically turns off the engine after it idles for a set period of time, which can be easily programmed from 5 to 60 minutes. An Eco-gauge and Eco guidance tips on the cab monitor further encourage efficient operations.

D155AX-8

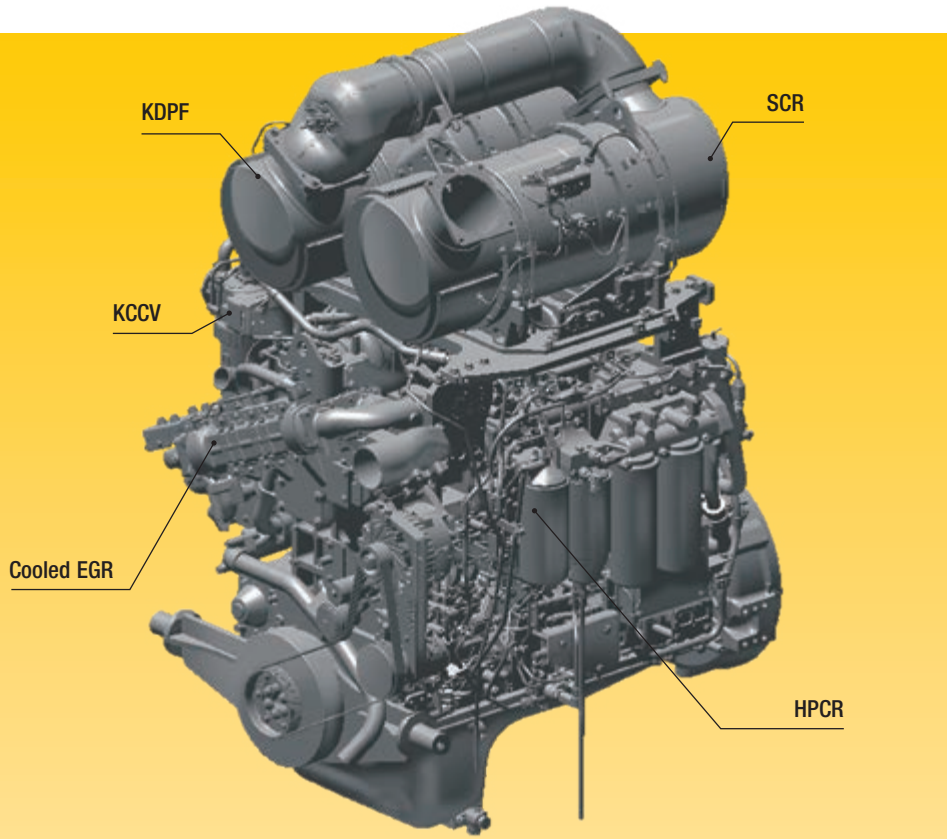
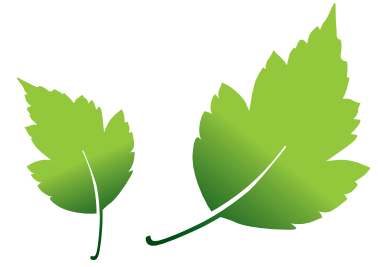

Komatsu EU Stage IV

The Komatsu EU Stage IV engine is productive, dependable and efficient. With ultra-low emissions, it provides a lesser environmental impact and a superior performance to help reduce operating costs and lets the operator work in complete peace of mind.

Heavy-duty aftertreatment

The aftertreatment system combines a Komatsu Diesel Particulate Filter (KDPF) and Selective Catalytic Reduction (SCR). The SCR system injects the correct amount of AdBlue® at the proper rate to break down NOx into water (H₂O) and nontoxic nitrogen gas (N₂). NOx emissions are reduced by 80% vs. EU Stage IIIB engines.

Exhaust Gas Recirculation (EGR)

Cooled EGR is a technology well-proven in current Komatsu engines. The increased capacity of the EGR cooler now ensures very low NOx emissions and a better engine performance.

Komatsu Closed Crankcase Ventilation (KCCV)

Crankcase emissions (blow-by gas) are passed through a CCV filter. The oil mist trapped in the filter is returned back to the crankcase while the filtered gas is returned to the air intake.

High-Pressure Common Rail (HPCR)

To achieve complete fuel burn and lower exhaust emissions, the heavy-duty High-Pressure Common Rail fuel injection system is computer controlled to deliver a precise quantity of pressurised fuel into the redesigned engine combustion chamber by multiple injections.

Variable Geometry Turbo (VGT)

The VGT provides optimal airflow to the engine combustion chamber under all speed and load conditions. Exhaust gas is cleaner, fuel economy is improved while machine power and performance are maintained.

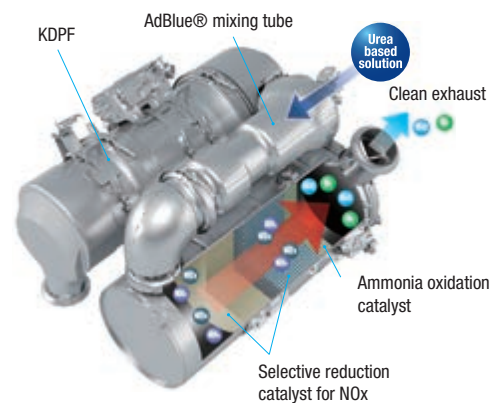

Automatic gearshift mode to further reduce fuel consumption



Eco-gauge, Eco guidance and fuel consumption gauge



Fuel consumption history

Optimised Work Equipment

Komatsu blades

For increased blade performance and better machine balance, Komatsu uses a box blade design, with the highest resistance for a light weight blade. Special Komatsu highly wear resistant steel is used for the front and sides of the blade to increase durability. The deep curved design of the blade makes it easy to handle a wide range of materials, with good penetration and a large capacity, optimising high dozing performance with excellent fuel efficiency.

Automatic blade pitch and ripper return

To reduce operator effort and increase efficiency while dozing, a new “auto pitch” mode, triggered by a simple switch, sets the blade pitch between “digging” and “dump” positions. Additionally, a new ergonomic ripper control lever with an auto-return function automatically raises the ripper when moved into reverse.

Komatsu rippers

Komatsu’s ripper concept, with all cylinders connected to the ripper shank holder, allows maximum pry-out force. Its key feature is the ripper point movement that lifts the material during the ripper shank operation to greatly improve overall performance. The shank supplies great penetration into various types of materials and is fitted with special wear parts for increased longevity.

Sigmodozer® blade

The middle section of Komatsu’s Sigmodozer® blade acts like a V-shaped bucket with aggressive ground penetration. Its lateral blade edges help to push the rolling material continuously towards the centre. Combined with the blade’s deep curve, this largely increases effective capacity and reduces spillage and fuel consumption. The blade’s flat cutting edge and the standard pitch function also offer top grading performance. Overall, the Sigmodozer® blade increases dozing productivity by more than 15% compared to a conventional Semi-U blade.

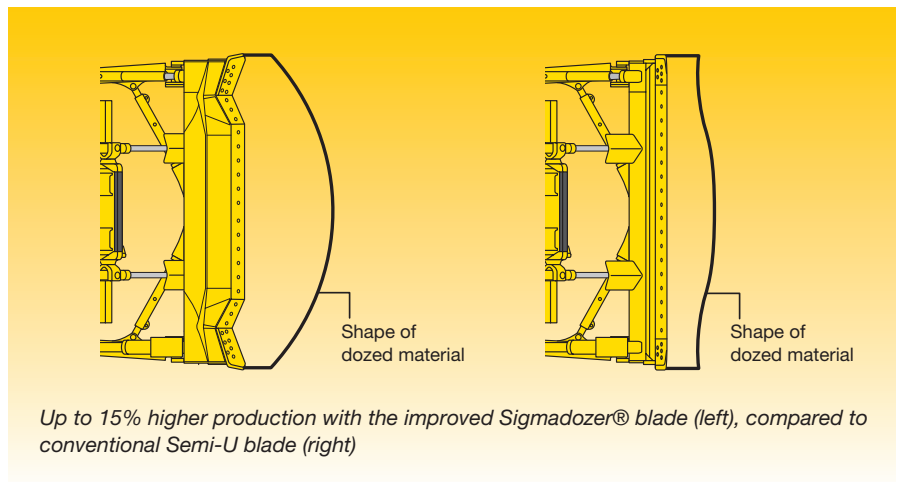

The Sigmodozer® blade offers highest material holding capacity



Semi-U blade



First-Class Comfort

Quiet and comfortable cab

Operator comfort is essential for safe and productive work. The cab on the D155AX-8 is quiet and comfortable, an ideal environment to concentrate on the job. Its hexagonal design and large tinted glass windows offer excellent panoramic visibility. The high capacity and fully automatic climate control system pressurises the cab to keep dust out. A high quality sound-absorbent lining covers the interior to minimise noise levels for the operator.

Fully adjustable suspension seat and travel-control console

A comfortable, heavy-duty and fully adjustable heated air-suspended seat is at the centre of the operator's safe and cosy work space. For dozing operations, the seat faces straight forward, with a perfect view of both sides of the blade. For ripping, it can be turned 15° to the right to significantly improve rear visibility and reduce neck strain. The position of the travel control console can also be independently adjusted forwards, backwards and in height to fit each operator's preference.

Superior visibility on blade and ripper

The redesigned ROPS/FOPS integrated cab and the well-located operator seat give optimal blade visibility to the left and right and make both dozing and grading easy, safe and fast. To further improve safety and ripping efficiency, the special shape of the fuel tank gives the operator a clear view of the ripper point and of the dozer's back side.



State-of-the-Art Controls



Hydrostatic steering system

The hydrostatic steering system (HSS) offers fast response and more precise turning. Both tracks are powered without interruption allowing smooth, continuous turns and powerful and productive dozing even on soft ground or on slopes.

Gearshift preset function

To reduce the frequency of gear shifting and for comfortable machine operation, a shift preset mode is provided as standard equipment. The preset switch lets the operator select a combination of forward/reverse gear shifts by using the UP/DOWN shift switch on the steering lever. Once the shift pattern is selected, only forward/reverse direction control selection is required for a correct gear shift.

Easy and precise

The ergonomic Palm Command Control System (PCCS) provides efficient and comfortable steering. The new control levers are fingertip controlled for precise and fatigue-free operating. When backing up over shot rock or other rough surfaces, travel speed can be reduced with the “slow reverse” function to improve ride quality and decrease vibrations and fuel consumption.

Selectable working modes

Working mode can be set to either “Power” for maximum power or to “Economy” for energy saving operations. Combined with a choice between automatic or manual working mode, this lets the operator select the optimum machine power configuration for the work at hand.



Palm Command Control System (PCCS)



Blade control lever with auto-pitch and new ripper control lever with auto-return function



Fully integrated rear-view camera system

Information & Communication Technology



Lower operating costs

Komatsu ICT contributes to the reduction of operating costs by assisting to comfortably and efficiently manage operations. It raises the level of customer satisfaction and the competitive edge of our products.

Widescreen monitor

Conveniently customisable and with a choice of 26 languages, the widescreen monitor with simple switches and multifunction keys gives fingertip access to a large range of functions and operating info. An AdBlue® level gauge is now incorporated into the default main screen.

An evolutionary interface

Helpful information is now easier than ever to find and understand with the upgraded monitor interface. The main screen can be simply optimised to the operator's preference by just pressing one button.



At a glance: operation logs



All information at a glance

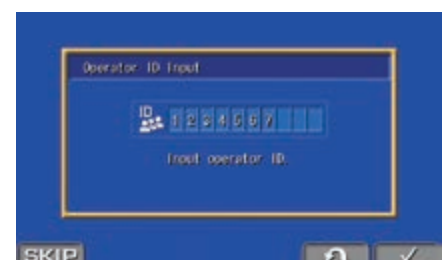

Operator identification function

D155AX-8

KOMTRAX

The way to higher productivity

KOMTRAX uses the latest wireless monitoring technology. Compatible on PC, smartphone or tablet, it delivers insightful and cost saving information about your fleet and equipment, and offers a wealth of information to facilitate peak machine performance. By creating a tightly integrated web of support it allows proactive and preventive maintenance and helps to efficiently run a business.



Knowledge

You get quick answers to basic and critical questions about your machines – what they're doing, when they did it, where they're located, how they can be used more efficiently, and when they need to be serviced.

Performance data is relayed by wireless communication technology (Satellite, GPRS or 3G depending on model) from the machine to a computer and to the local Komatsu distributor – who's readily available for expert analysis and feedback.

Power

The detailed information that KOMTRAX puts at your fingertips 24 hours a day, 7 days a week gives the power to make better daily and long-term strategic decisions – at no extra cost. Problems can be anticipated, maintenance schedules customised, downtime minimised and machines kept where they belong: working on the jobsite.

Convenience

KOMTRAX enables convenient fleet management on the web, wherever you are. Data is analysed and packaged specifically for effortless and intuitive viewing in maps, lists, graphs and charts. You can foresee eventual maintenance issues and required spare parts, and troubleshoot a problem before Komatsu technicians arrive on site.



Easy Maintenance



Komatsu CARE™

Komatsu CARE™ is a maintenance program that comes as standard with your new Komatsu machine. It covers factory-scheduled maintenance, performed with Komatsu Genuine parts by Komatsu-trained technicians. Depending on your machine's engine, it also offers extended coverage of the Komatsu Diesel Particulate Filter (KDPF) or the Komatsu Diesel Oxidation Catalyst (KDOC), and of the Selective Catalytic Reduction (SCR). Please contact your local Komatsu distributor for terms and conditions.

Reversible radiator fan

The radiator can be easily cleaned by utilisation of the reversible, hydraulically driven cooling fan from a touch on the monitor panel. This cleaning reduces fuel consumption and increases overall machine performance.



Central service points

Komatsu designed the D155AX-8 with centralised and conveniently located service points to make necessary inspections and maintenance quick and easy.

Modular power train

All the power train components are enclosed in a sealed module. This eliminates oil spills during mounting and dismounting, and prevents dust and dirt polluting individual components. Servicing is much cleaner, smoother and easier.



Self-diagnostic monitor

The multifunction monitor panel displays the running time, engine revs, fuel level and water coolant temperature in real time. It also provides the operator with maintenance and service information, if oil filters need replacing or any abnormality occurs. In addition, it supplies Komatsu mechanics with detailed information, with no need for external service tools.



D155AX-8

Tough and Reliable

Sturdy, rugged design

A high-rigidity hull structure main frame improves durability and reduces stress concentration at critical areas. The track frame with a large cross section utilises pivot shaft mounting for greater reliability. All hydraulic piping is robustly protected by cover and inner route to ensure damage protection from materials.

K-Bogie undercarriage system

The K-Bogie undercarriage is built with flexible mounted bogie systems that allow a high vertical track roller movement. The 7 track roller/K-bogie design supports and guides the tracks on all ground conditions for a much smoother drive and a longer undercarriage life.

Highly reliable electric circuit

The new generation of Komatsu dozers have special reinforced electrical wiring harnesses covered with a heat-resistant material that improves mechanical strength, provides longer life, and protects the system from damage. The reliability of the D155AX-8's electrical circuit is further increased by the use of "DT connectors" that have a very high resistance to dust, corrosion and moisture and keep your machine up and running.

Protected hydraulic piping

Komatsu has designed the hydraulics of the working equipment so it minimises maintenance costs. All the hydraulic lines are well protected with special linings and embedded into the steel structures whenever possible.

Low-drive "PLUS" undercarriage (option)

Komatsu's low-drive Parallel Link Undercarriage System (PLUS) is extraordinarily tough, with excellent grading performance and stability. It features PLUS link assemblies, a highly reliable floating bushing concept, substantial track link height, superior oil seals and track guards that maximise undercarriage durability. For easier servicing, the equaliser bar's centre pin is remotely greased. The segmented sprockets are notched to considerably improve the evacuation of mud and further increase the PLUS undercarriage lifetime.



K-Bogie undercarriage system

Fulcrum of major bogie

Fulcrum of minor bogie

Specifications

ENGINE

Model	Komatsu SAA6D140E-7
Type	Common rail direct injection, water-cooled, emissionised, turbocharged, after-cooled diesel
Engine power	
at rated engine speed	1.900 rpm
ISO 14396	268 kW/360 HP
ISO 9249 (net engine power)	264 kW/354 HP
No. of cylinders	6
Bore × stroke	140 × 165 mm
Displacement	15,24 l
Fan drive type	Hydraulic, reversible
Lubrication system	
Method	Gear pump, force lubrication
Filter	Full flow

ENVIRONMENT

Engine emissions	Fully complies with EU Stage IV exhaust emission regulations
Noise levels	
LwA external	112 dB(A) (2000/14/EC Stage II)
LpA operator ear	80 dB(A) (ISO 6396 dynamic test)
Vibration levels (EN 12096:1997)	
Hand/arm	≤ 2,5 m/s ² (uncertainty K = 0,79 m/s ²)
Body	≤ 0,5 m/s ² (uncertainty K = 0,24 m/s ²)
Contains fluorinated greenhouse gas HFC-134a (GWP 1430). Quantity of gas 0,9 kg, CO ₂ equivalent 1,29 t	

MAX. TRAVEL SPEEDS

	Forward	Reverse
1st	3,5 km/h	4,3 km/h
2nd	5,6 km/h	6,8 km/h
3rd L	7,5 km/h	9,2 km/h
3rd	11,6 km/h	14,0 km/h

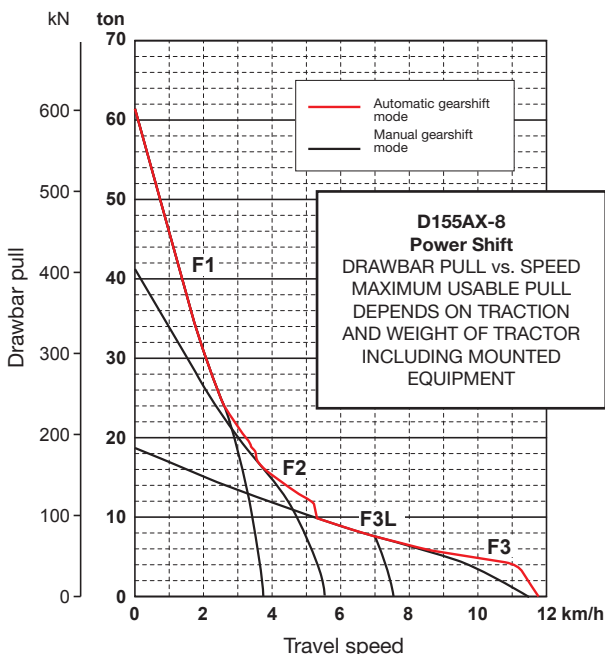

STEERING SYSTEM

Type	Hydrostatic Steering System (HSS)
Steering control	PCCS-lever
Service brakes	Wet, multiple-disc, pedal-controlled, spring-actuated and hydraulically released
Minimum turning radius (counter-rotation)	
(as measured by track marks on ground)	2,14 m

UNDERCARRIAGE

Suspension	Oscillating equaliser bar and pivot shaft
Track roller frame	Monocoque, large section, durable construction
K-Bogie undercarriage	Lubricated track rollers are resiliently mounted on the track frame with a bogie suspension system
Tracks	Lubricated tracks, fully sealed
Track tension	Combined spring and hydraulic unit
Number of shoes (each side)	42
Grouser height (single grouser)	80 mm
Shoe width (standard)	610 mm
Ground contact area (ISO16754)	45.399 cm ²
Ground pressure (ISO16754)	0,92 kg/cm ²
Track rollers (each side)	7
Carrier rollers (each side)	2

OPERATING WEIGHT (APPR.)

Including strengthened Sigmadozer®, giant ripper, steel cab, ROPS, operator, standard equipment, rated capacity of lubricant, coolant, and full fuel tank	
Operating weight	41.690 kg

SERVICE REFILL CAPACITIES

Fuel tank	625 l
Radiator	104 l
Engine oil	37 l
Damper	1,5 l
Torque converter, transmission, bevel gear and steering system	90 l
Dozer blade hydraulics	95 l
Giant ripper (additional capacity)	37 l
Multishank ripper (additional capacity)	37 l
Final drive (each side)	31 l
AdBlue® tank	59,0 l

FINAL DRIVE

Type	Planetary gear, double-reduction
Sprocket	Segmented sprocket teeth are bolt-on for easy replacement

TORQFLOW TRANSMISSION

Type	Komatsu TORQFLOW
Torque converter	3-element, 1-stage, 1-phase, water-cooled, automatic lock-up
Transmission	Planetary gear, multiple-disc clutch hydraulically actuated, force-lubricated
Gearshift lock lever and neutral safety switch prevent accidental starts.	

RIPPER EQUIPMENT

Multishank ripper	
Type	Hydraulically controlled variable ripper
No. of shanks	3
Weight (including hydraulic control unit)	3.760 kg
Beam length	2.320 mm
Maximum lift above ground	950 mm
Maximum digging depth	900 mm
Giant ripper	
Type	Hydraulically controlled variable ripper
No. of shanks	1
Weight (including hydraulic control unit)	2.440 kg
Beam length	1.400 mm
Maximum lift above ground	950 mm
Maximum digging depth	1.240 mm

HYDRAULIC SYSTEM

Type	CLSS (closed-centre load sensing system)
All spool valves externally mounted beside the hydraulic tank.	
Main pump	Variable displacement piston pump
Maximum steering pump flow	325 l/min
Relief valve setting	390 kg/cm ²
Maximum implement pump flow	180 l/min
Relief valve setting	280 kg/cm ²
Spool control valve positions	
Blade lift	Raise, hold, lower, and float
Blade tilt	Right, hold, and left
Additional control valve positions for ripper	
Ripper lift	Raise, hold and lower
Ripper tilt	Increase, hold and decrease
Hydraulic cylinders	
No. of cylinders × bore	
Blade lift	2 × 110 mm
Blade tilt	2 × 160 mm
Ripper lift	1 × 180 mm
Ripper tilt	1 × 200 mm

DOZER EQUIPMENT

	Overall length with blade	Blade capacity	Blade width × height	Max. lift above ground	Max. drop below ground	Max. tilt adjustment	Assembly weight
Strengthened Sigmadozer® dual tilt	6.300 mm	9,4 m ³	4.060 × 1.880 mm	1.315 mm	680 mm	880 mm	5.900 kg
Strengthened Semi-U blade dual tilt	6.365 mm	9,4 m ³	4.130 × 1.790 mm	1.315 mm	600 mm	880 mm	5.900 kg
Strengthened U-Blade dual tilt	6.785 mm	11,9 m ³	4.260 × 1.790 mm	1.315 mm	600 mm	920 mm	6.170 kg

Blade capacities are based on the SAE recommended practice J1265.

DIMENSIONS

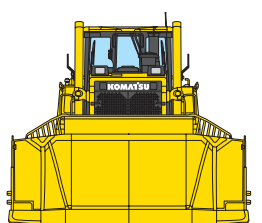
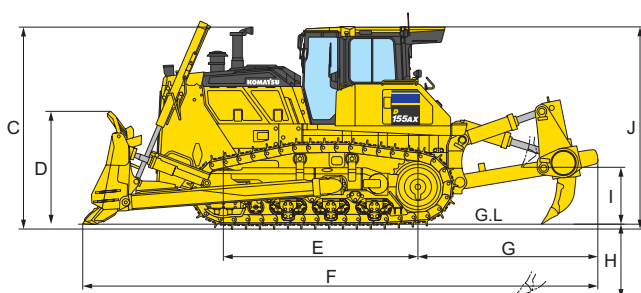
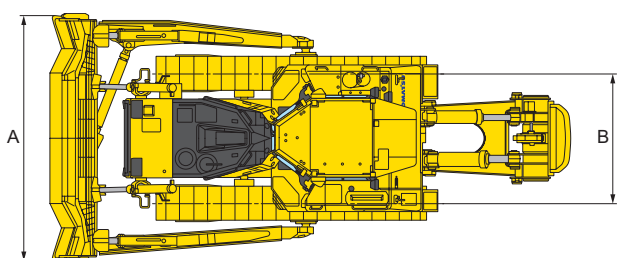

Ground clearance: 500 mm (+ grouser height)

D155AX-8 Sigmadozer®

A	4.060 mm
B	2.140 mm
C	3.385 mm
D	1.850 mm
E	3.275 mm
F	8.700 mm
G	3.045 mm
H	1.240 mm
I	950 mm
J	3.390 mm

Standard and Optional Equipment

ENGINE AND RELATED PARTS

Komatsu SAA6D140E-7 turbocharged common rail direct injection diesel engine	●
EU Stage IV compliant	●
Fuel pre-filter (10 micron) and fuel filter (2 micron)	●
Intake pipe with rain cap	●
Starting motor 24 V/11 kW	●
Alternator 24 V/140 A	●
Batteries 2 × 12 V/136 Ah	●
Gull wing engine side covers	●
Cooling fan, hydrostatic driven with reversing function	●
Fuel tank inlet strainer	●
Electric type engine oil and coolant heater	○
High-capacity batteries 2 × 12 V/220 Ah	○
Cyclone type air pre-cleaner	○

UNDERCARRIAGE

Single grouser heavy-duty shoes (610 mm)	●
Heavy-duty link assembly, sealed and lubricated	●
Segmented sprockets	●
K-Bogie system	●
Hydraulic track adjusters	●
Single grouser heavy-duty shoes (560 mm, 660 mm, 710 mm)	○
Heavy-duty PLUS undercarriage	○
Full length track roller guard	○

SERVICE AND MAINTENANCE

Dry type air cleaner, double element with dust indicator and evacuator	●
Water separator	●
Multifunction video compatible colour monitor with Equipment Management and Monitoring System (EMMS) and efficiency guidance	●
KOMTRAX – Komatsu wireless monitoring system (3G)	●
Komatsu CARE™ – a maintenance program for Komatsu customers	●
Tool kit	●
Grease gun holder	●
Provisions for fast fueling system	●

CABIN

Heated air-suspended seat: fabric, reclining, high backrest, turnable	●
Seat belt with visible alert	●
High mount footrest	●
Automatic air conditioner	●
Radio	●
Auxiliary input (MP3 jack)	●
2 × 12 Volt power supply (120 W)	●
1 × 24 Volt power supply	●
Viscous cab mounts	●
Wiper front and rear window	●
Wipers doors	●
Rear-view mirror (inside cab)	●
Heated rear window	●
Sun visor (rear)	●
Cup holder	●
Lunch box holder	●

TRANSMISSION AND BRAKES

Automatic hydroshift transmission	●
Torque converter with automatic lock-up	●
Damper	●
Quick shift selection system	●
HSS hydrostatic steering system	●
Palm lever steering control (PCCS)	●
Decelerator pedal	●
Brake pedal	●

SAFETY EQUIPMENT

Steel cab, meets ISO 3471 and SAE J1040, APR88 ROPS standards, as well as ISO 3449 FOPS standards	●
Back-up alarm	●
Warning horn	●
Rear-view camera system	●
Battery main switch	●
Locks, filter caps and covers	●
Fire extinguisher	○
First aid kit	○
Emergency steering	○

HYDRAULIC SYSTEM

Hydraulics for dozing blades	●
Mono lever blade control	●
Hydraulics for ripper	●

LIGHTING SYSTEM

2 working light, rear	●
4 cab lights, front and rear	●
2 head lights	●
1 ripper working light	●

ATTACHMENTS

Front pull hook	●
Rigid drawbar	●
Counterweight + hitch	○
Multishank variable angle ripper	○
Giant variable angle ripper	○

DOZER EQUIPMENT

Strengthened Sigmadozer® dual tilt, 9,4 m³	●
Strengthened Semi-U blade dual tilt, 9,4 m³	○
Strengthened U blade dual tilt, 11,9 m³	○

Further equipment on request

- standard equipment
- optional equipment

Your Komatsu partner:

KOMATSU

**Komatsu Europe
International N.V.**

Mechelsesteenweg 586
B-1800 VILVOORDE (BELGIUM)
Tel. +32-2-255 24 11
Fax +32-2-252 19 81
www.komatsu.eu

EENSS20103 03/2019

KOMATSU is a trademark of Komatsu Ltd. Japan.