

KOMATSU

PC490-11 **PC490LC-11**

EU Stage V Engine

HYDRAULIC EXCAVATOR



PC490

ENGINE POWER

270 kW / 362 HP @ 1.900 rpm

OPERATING WEIGHT

PC490-11: 46.470 - 47.410 kg
PC490LC-11: 47.370 - 48.860 kg

BUCKET CAPACITY

max. 3,50 m³

Walk-Around

PC490/490LC-11



ENGINE POWER

270 kW / 362 HP @ 1.900 rpm

OPERATING WEIGHT

PC490-11: 46.470 - 47.410 kg
PC490LC-11: 47.370 - 48.860 kg

BUCKET CAPACITY

max. 3,50 m³



EXCEPTIONAL WORKABILITY AND ENVIRONMENTAL PERFORMANCE

Powerful and Environmentally Friendly

- EU Stage V engine
- Adjustable idle shutdown
- Komatsu fuel-saving technology

First-Class Comfort

- Fully air-suspended operator station
- Low-noise design
- Widescreen monitor with evolutionary interface

Maximised Efficiency

- Up to 11% less fuel consumption
- Built-in versatility and superior productivity
- Enhanced engine management
- Lower hydraulic pressure loss
- Komatsu Integrated Attachment Control (KIAC)

Safety First

- Komatsu SpaceCab™ (FOPS optional)
- KomVision surround view system
- Neutral position detection system

Quality You Can Rely On

- Komatsu-quality components
- Extensive dealer support network

KOMTRAX

- Komatsu Wireless Monitoring System
- 3G mobile communications
- Integrated communication antenna
- Increased operational data and fuel savings



A maintenance program
for Komatsu customers

Powerful and Environmentally Friendly



Higher productivity

The PC490/LC-11 is quick and precise. It features a powerful Komatsu EU Stage V engine, Komatsu's Closed Center Load Sensing (CLSS) hydraulic system and first-class Komatsu comfort to provide a fast response and unrivalled productivity for its class.

Komatsu fuel-saving technology

Fuel consumption on the PC490/LC-11 is lower by up to 11%. Engine management is enhanced. The variable speed matching of the engine and hydraulic pumps guarantee efficiency and precision during single and combined movements.

Adjustable idle shutdown

The Komatsu auto idle shutdown automatically turns off the engine after it idles for a set period of time. This feature can easily be programmed from 5 to 60 minutes, to reduce unnecessary fuel consumption and exhaust emissions, and to lower operating costs. An Eco-gauge and the Eco guidance tips on the cab monitor further encourage efficient operations.

PC490/490LC-11

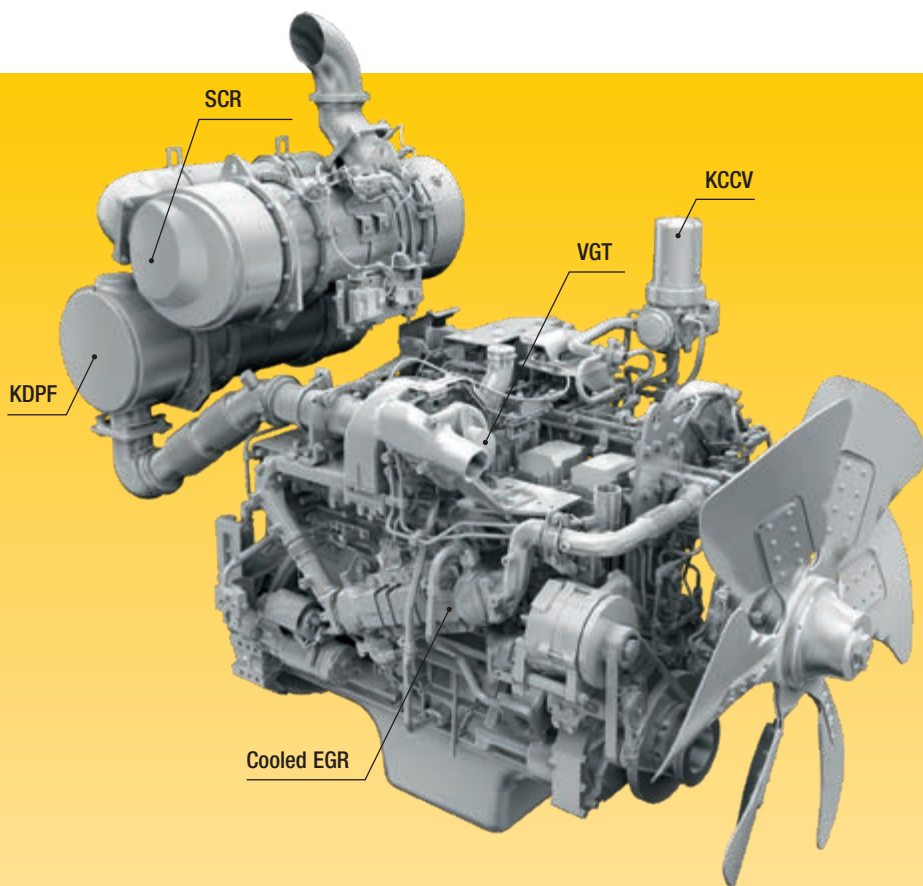

Komatsu EU Stage V

The Komatsu EU Stage V engine is productive, dependable and efficient. With ultra-low emissions, it provides a lower environmental impact and a superior performance to help reduce operating costs and lets the operator work in complete peace of mind.

Heavy-duty aftertreatment

The aftertreatment system combines a Komatsu Diesel Particulate Filter (KDPF) and Selective Catalytic Reduction (SCR). The SCR injects the correct amount of AdBlue® into the system at the proper rate to break down NOx into water (H₂O) and non-toxic nitrogen gas (N₂). NOx emissions are reduced by 80% vs. EU Stage IIIB engines.

Exhaust Gas Recirculation (EGR)

Cooled EGR is a technology well-proven in current Komatsu engines. The increased capacity of the EGR cooler now ensures very low NOx emissions and a better engine performance.

Komatsu Closed Crankcase Ventilation (KCCV)

Crankcase emissions (blow-by gas) are passed through a CCV filter. The oil mist trapped in the filter is returned back to the crankcase while the filtered gas is returned to the air intake.

High-Pressure Common Rail (HPCR)

To achieve complete fuel burn and lower exhaust emissions, the heavy-duty High-Pressure Common Rail fuel injection system is computer controlled to deliver a precise quantity of pressurised fuel into the redesigned engine combustion chamber by multiple injections.

Variable Geometry Turbo (VGT)

The VGT provides optimal airflow to the engine combustion chamber under all speed and load conditions. Exhaust gas is cleaner, fuel economy is improved while machine power and performance are maintained.

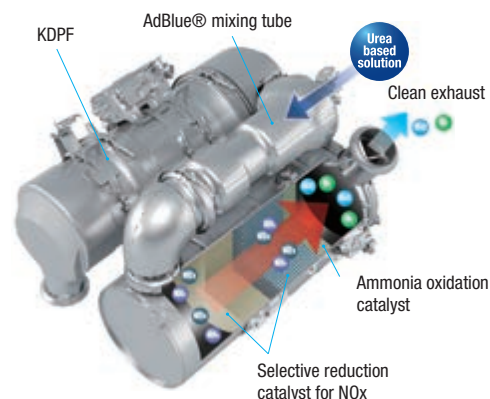

Eco-gauge, Eco guidance and fuel consumption gauge



Eco guidance record



Fuel consumption history

Maximised Efficiency

Large digging force

The two boom mode settings provide a “power” mode for a more effective excavating digging force and a “smooth” mode for gathering material and for fine grading operations. Pressing the PowerMax function button temporarily gives the PC490/LC-11’s digging force a further boost.

6 working modes

The PC490/LC-11 delivers the power required with the lowest fuel usage. 6 working modes are available: Power, Lifting/Fine Operation, Breaker, Economy, Attachment Power and Attachment Economy. The operator can ideally balance the Economy mode between power and economy to match the work at hand. The oil flow delivered to hydraulic attachments is also adjustable directly on the class-leading widescreen monitor panel.

Built-in versatility

Powerful and precise, the Komatsu PC490/LC-11 is equipped to efficiently carry out any task your business requires. On all jobsites, big or small, for digging, trenching, landscaping or site preparation, the Komatsu hydraulic system always provides maximum productivity and control.

A wide choice of options

Two optional attachment lines are available and 15 attachment memory settings are simply customised. Combined with a standard-fit hydraulic quick coupler power circuit, it’s easier than ever to switch working styles. For tougher loading applications, the lift capacity and productivity of the PC490/LC-11 can be further enhanced with a short 6,7 m boom, double grouser track shoes, full length track roller guards and an OPG top and a front guard.



Versatility at your fingertips: select the perfect setting for each job



Komatsu Integrated Attachment Control (KIAC) for up to 15 tool presets for oil flow and pressure



PC490/490LC-11



First-Class Comfort

Increased comfort

In the wide Komatsu SpaceCab™, a standard air-suspended high-back seat, heated for improved comfort and with fully adjustable armrests, is the centre of a comfortable and low-fatigue working environment. High visibility and ergonomic controls further assist to maximise the operator's productivity.

Perfect operator convenience

In addition to the standard radio, the PC490/LC-11 has an auxiliary input for connecting external devices and play music through the cab speakers. Two 12-volt power ports are also incorporated in the cab. Proportional controls are fitted as standard for safe and precise operation of attachments.

Low-noise design

Komatsu crawler excavators have very low external noise levels and are especially well-suited for work in confined spaces or urban areas. The optimal usage of sound insulation and of sound absorbing materials helps to make noise levels inside the cab comparable to those of an executive car.



Convenient, ergonomic and precise control: joysticks with proportional control button for attachments



Plenty of storage room, a hot and cool box, a magazine box and a cup holder



Armrest with simple height adjustment

Information & Communication Technology

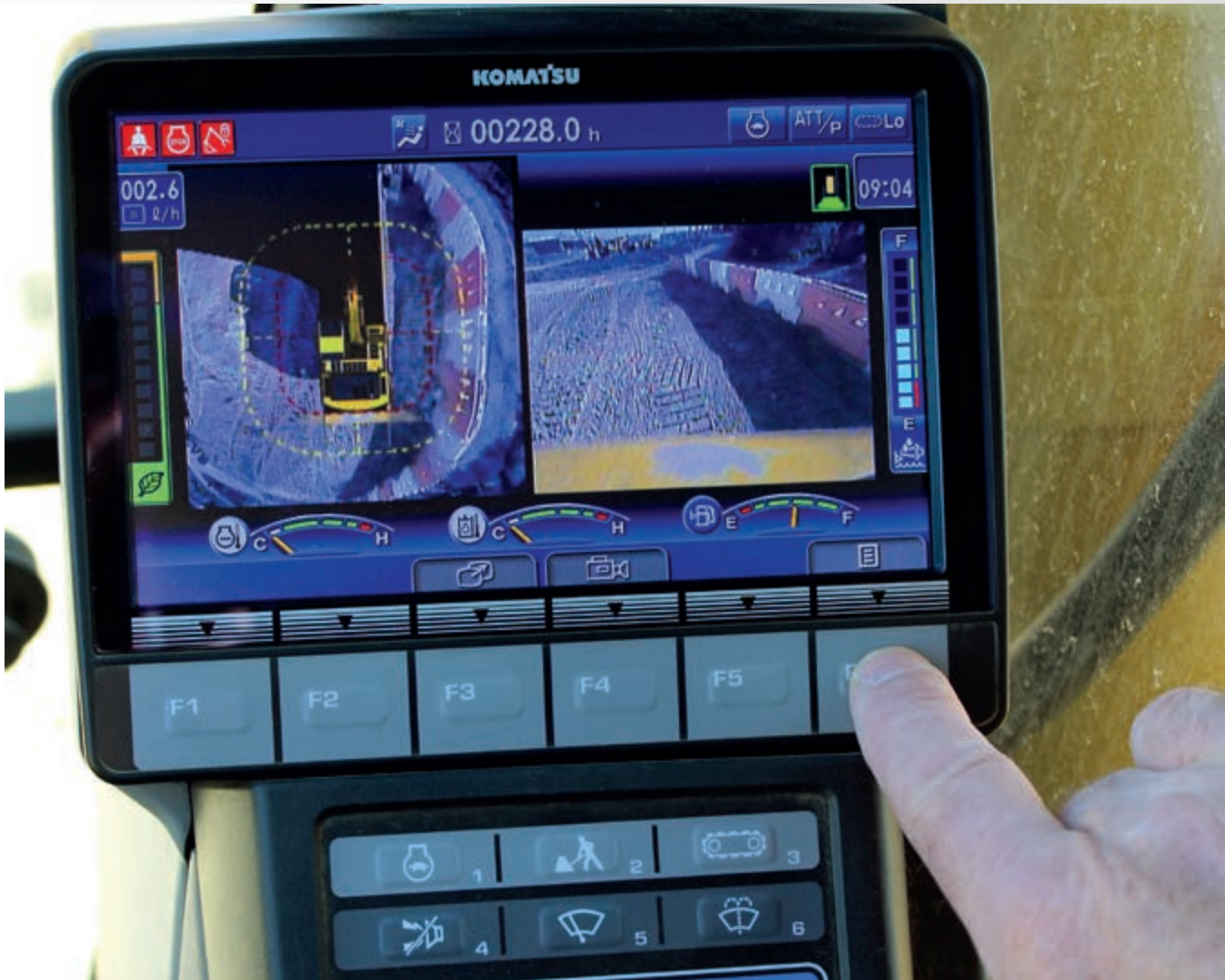

Lower operating costs

Komatsu ICT contributes to the reduction of operating costs by assisting to comfortably and efficiently manage operations. It raises the level of customer satisfaction and the competitive edge of our products.

Widescreen monitor

Conveniently customisable and with a choice of 26 languages, the wide-screen monitor with simple switches and multifunction keys gives fingertip access to a large range of functions and operating info. The rear camera view and an AdBlue® level gauge are now incorporated into the default main screen.

An evolutionary interface

Helpful information is now easier than ever to find and understand with the upgraded monitor interface. An optimal main screen for the ongoing work can be selected simply by pressing the F3 key.



Quick view on the operation logs



With KomVision, various camera view options are available whilst maintaining constant "birdview" from above the machine



Operator identification function

Safety First

PC490/490LC-11



Optimal jobsite safety

Safety features on the Komatsu PC490/LC-11 comply with the latest industry standards and work in synergy to minimise risks to people in and around the machine. A neutral detection system for travel and work equipment levers increase jobsite safety, along with a seat belt caution indicator and an audible travel alarm. Highly durable anti-slip plates – with additional high friction covering – maintain long term traction performance.



KomVision cameras



Exceptional operator protection



Hand rails and anti-slip plates

KomVision

KomVision machine visibility gives the operator a constant clear view of the safety zone around the machine. This allows the operator to focus on the work at hand even in low light conditions.

Komatsu SpaceCab™

The ROPS cab has a tubular steel frame and provides high shock absorbency, impact resistance and durability. The seat belt is well designed to keep the operator in the safety zone of the cab in the event of a rollover. Optionally the cab can be fitted with a Falling Object Protective System (FOPS) with openable front guard.

Safe maintenance

Thermal guards around high temperature areas of the engine, protected fan belt and pulleys, a pump/engine partition that prevents hydraulic oil from spraying onto the engine, and exceptionally sturdy handrails: in Komatsu tradition, the highest safety level is provided for a fast and smooth maintenance.

Quality You Can Rely On

Komatsu-quality

With the latest computer techniques and a thorough test programme, Komatsu produces equipment to meet your highest standards. All major components of the PC490/LC-11 are designed and directly manufactured by Komatsu, and essential machine functions are perfectly matched for a highly reliable and productive excavator.

Rugged design

Maximum toughness and durability are the cornerstones of Komatsu's philosophy – along with safety and top class customer service. Single piece plates and castings are used in key areas of the machine's structure for good load distribution. Highly durable rubbing strips on the underside of the arm protect the structure against impact damage.

Extensive support network

The extensive Komatsu distribution and dealer network is standing by to help keep your fleet in optimum condition. Customised servicing packages are available, with express availability of spare parts, to make sure that your Komatsu equipment continues to perform at its peak.



Durable and reliable undercarriage design for maximum protection



Work equipment designed for strength and durability

Easy Maintenance



Central service points

Komatsu designed the PC490/LC-11 with centralised and conveniently located service points to make necessary inspections and maintenance quick and easy.

Komatsu CARE™

Komatsu CARE™ is a maintenance program that comes as standard with your new Komatsu machine. It covers factory-scheduled maintenance, performed with Komatsu Genuine parts by Komatsu-trained technicians. Depending on your machine's engine, it also offers extended coverage of the Komatsu Diesel Particulate Filter (KDPF) or the Komatsu Diesel Oxidation Catalyst (KDOC), and of the Selective Catalytic Reduction (SCR). Please contact your local Komatsu distributor for terms and conditions.



Long-life oil filters

The Komatsu Genuine hydraulic oil filter uses high-performance filtering material for long replacement intervals, which significantly reduces maintenance costs.



AdBlue® tank

For simple access, the AdBlue® tank is installed on the front stairway.

Flexible warranty

When you purchase Komatsu equipment, you gain access to a broad range of programmes and services that have been designed to help you get the most from your investment. For example, Komatsu's Flexible Warranty Programme provides a range of extended warranty options on the machine and its components. These can be chosen to meet your individual needs and activities. This programme is designed to help reduce total operating costs.

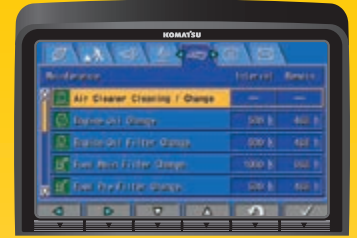

Basic maintenance screen

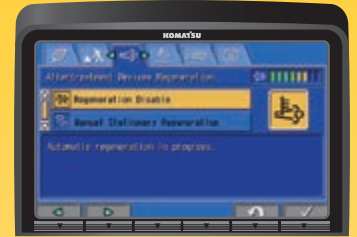

Aftertreatment device regeneration screen for the KDPF



AdBlue® level and refill guidance



KOMTRAX

The way to higher productivity

KOMTRAX uses the latest wireless monitoring technology. Compatible on PC, smartphone or tablet, it delivers insightful and cost saving information about your fleet and equipment, and offers a wealth of information to facilitate peak machine performance. By creating a tightly integrated web of support it allows proactive and preventive maintenance and helps to efficiently run a business.



Knowledge

You get quick answers to basic and critical questions about your machines – what they're doing, when they did it, where they're located, how they can be used more efficiently and when they need to be serviced. Performance data is relayed by wireless communication technology (Satellite, GPRS or 3G depending on model) from the machine to a computer and to the local Komatsu distributor – who's readily available for expert analysis and feedback.

Power

The detailed information that KOMTRAX puts at your fingertips 24 hours a day, 7 days a week gives the power to make better daily and long-term strategic decisions – at no extra cost. Problems can be anticipated, maintenance schedules customised, downtime minimised and machines kept where they belong: working on the jobsite.

Convenience

KOMTRAX enables convenient fleet management on the web, wherever you are. Data is analysed and packaged specifically for effortless and intuitive viewing in maps, lists, graphs and charts. You can foresee eventual maintenance issues and required spare parts, and troubleshoot a problem before Komatsu technicians arrive on site.



Specifications

ENGINE

Model	Komatsu SAA6D125E-7
Type	Common rail direct injection, water-cooled, emissionised, turbocharged, after-cooled diesel
Engine power	
at rated engine speed	1.900 rpm
ISO 14396	270 kW/362 HP
ISO 9249 (net engine power)	268 kW/359 HP
No. of cylinders	6
Bore × stroke	125 × 150 mm
Displacement	11,04 l
Air filter type	Double element type with monitor panel dust indicator and auto dust evacuator
Cooling	Suction type cooling fan with radiator fly screen
Fan drive type	Hydraulic, reversible
Fuel	Diesel fuel, conforming to EN 590 Class 2/Grade D. Paraffinic fuel capability (HVO, GTL, BTL), conforming to EN 15940:2016

HYDRAULIC SYSTEM

Type	HydrauMind. Closed-centre system with load sensing and pressure compensation valves
Additional circuits	2 additional circuits with proportional control can be installed
Main pump	2 variable displacement piston pumps supplying boom, arm, bucket, swing and travel circuits
Maximum pump flow	2 × 345 l/min
Relief valve settings	
Implement	380 kg/cm ²
Travel	380 kg/cm ²
Swing	285 kg/cm ²
Pilot circuit	33 kg/cm ²

SERVICE REFILL CAPACITIES

Fuel tank	650 l
Radiator	47,0 l
Engine oil	37,0 l
Swing drive	20,0 l
Hydraulic tank	248 l
Final drive (each side)	10,5 l
AdBlue® tank	39,0 l

OPERATING WEIGHT (APPR.)

	PC490-11		PC490LC-11	
	Operating weight	Ground pressure	Operating weight	Ground pressure
Triple grouser shoes				
600 mm	46.470 kg	0,88 kg/cm ²	47.370 kg	0,84 kg/cm ²
700 mm	46.940 kg	0,76 kg/cm ²	47.870 kg	0,73 kg/cm ²
800 mm	47.410 kg	0,68 kg/cm ²	48.370 kg	0,64 kg/cm ²
900 mm	-	-	48.860 kg	0,58 kg/cm ²
Double grouser shoes				
600 mm	46.590 kg	0,89 kg/cm ²	47.490 kg	0,84 kg/cm ²

Operating weight, including specified work equipment, 7,1 m mono boom, 3,4 m arm, 1.915 kg bucket, operator, lubricant, coolant, full fuel tank and the standard equipment.

SWING SYSTEM

Type	Axial piston motor driving through planetary double reduction gearbox
Swing lock	Electrically actuated wet multidisc brake integrated into swing motor
Swing speed	0 - 9,1 rpm
Swing torque	132 kNm

DRIVES AND BRAKES

Steering control	2 levers with pedals giving full independent control of each track
Drive method	Hydrostatic
Travel operation	Automatic 3-speed selection
Gradeability	70%, 35°
Max. travel speeds	
Lo / Mi / Hi	3,0 / 4,2 / 5,5 km/h
Maximum drawbar pull	34.000 kg
Brake system	Hydraulically operated discs in each travel motor

UNDERCARRIAGE

Construction	X-frame centre section with box section track frames
Track assembly	
Type	Fully sealed
Shoes (each side)	46 (PC490), 49 (PC490LC)
Tension	Combined spring and hydraulic unit
Rollers	
Track rollers (each side)	7 (PC490), 8 (PC490LC)
Carrier rollers (each side)	2

ENVIRONMENT

Engine emissions	Fully complies with EU Stage V exhaust emission regulations
Noise levels	
LwA external	107 dB(A) (2000/14/EC Stage II)
LpA operator ear	71 dB(A) (ISO 6396 dynamic test)
Vibration levels (EN 12096:1997)	
Hand/arm	≤ 2,5 m/s ² (uncertainty K = 0,25 m/s ²)
Body	≤ 0,5 m/s ² (uncertainty K = 0,25 m/s ²)
Contains fluorinated greenhouse gas HFC-134a (GWP 1430). Quantity of gas 1 kg, CO ₂ equivalent 1,43 t	

Dimensions & Performance Figures

MACHINE DIMENSIONS	PC490-11	PC490LC-11
A Overall width of upper structure	2.995 mm	2.995 mm
B Overall height of cab	3.360 mm	3.360 mm
C Overall length of basic machine	6.135 mm	6.300 mm
D Tail length	3.605 mm	3.605 mm
Tail swing radius	3.645 mm	3.645 mm
E Clearance under counterweight	1.385 mm	1.385 mm
F Machine tail height	2.560 mm	2.560 mm
F' Machine tail height (top of engine cover)	3.630 mm	3.630 mm
G Ground clearance	700 mm	700 mm
H Tumbler centre distance	4.020 mm	4.350 mm
I Track length	5.055 mm	5.385 mm
J Track gauge	2.890 mm	2.890 mm
K Track shoe width	600, 700, 800 mm	600, 700, 800, 900 mm
L Overall track width with 600 mm shoes	3.490 - 2.990 mm*	3.490 - 2.990 mm*
Overall track width with 700 mm shoes	3.590 - 3.090 mm*	3.590 - 3.090 mm*
Overall track width with 800 mm shoes	3.690 - 3.190 mm*	3.690 - 3.190 mm*
Overall track width with 900 mm shoes	-	3.790 - 3.290 mm*

* Transport dimensions (retracted)

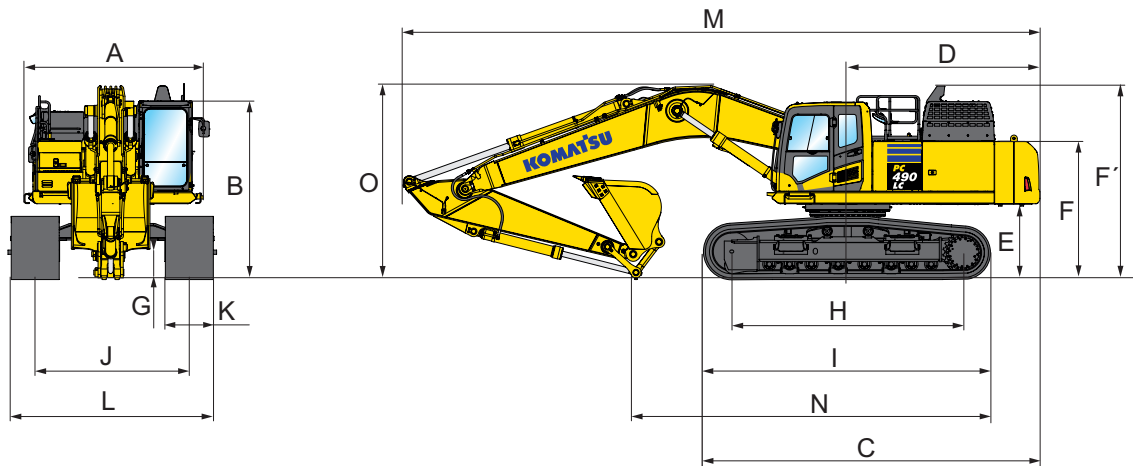

TRANSPORT DIMENSIONS	MONO BOOM				
Arm length	2,4 m	2,9 m	3,4 m	4,0 m	4,8 m
M Transport length	11.910 mm	12.000 mm	11.930 mm	11.950 mm	11.825 mm
N Length on ground (transport) (PC490-11)	7.720 mm	7.455 mm	6.710 mm	6.130 mm	5.885 mm
Length on ground (transport) (PC490LC-11)	7.885 mm	7.620 mm	6.875 mm	6.295 mm	6.050 mm
O Overall height (to top of boom)	3.875 mm	3.760 mm	3.635 mm	3.885 mm	4.435 mm

TRANSPORT DIMENSIONS	SHORT BOOM	
Arm length	2,4 m	2,9 m
M Transport length	11.470 mm	11.570 mm
N Length on ground (transport) (PC490-11)	7.675 mm	7.210 mm
Length on ground (transport) (PC490LC-11)	7.840 mm	7.380 mm
O Overall height (to top of boom)	3.630 mm	3.710 mm

Dimensions & Performance Figures

PC490-11 / MAX. BUCKET CAPACITY AND WEIGHT

Arm length	MONO BOOM					
	2,4 m	2,9 m	3,4 m	4,0 m	4,8 m	
Material weight up to 1,2 t/m ³	2,76 m ³ 2.175 kg	2,76 m ³ 2.175 kg	2,76 m ³ 2.175 kg	2,76 m ³ 2.175 kg	2,76 m ³ 2.175 kg	2,76 m ³ 2.175 kg
Material weight up to 1,5 t/m ³	2,76 m ³ 2.175 kg	2,76 m ³ 2.175 kg	2,76 m ³ 2.175 kg	2,76 m ³ 2.175 kg	2,73 m ³ 2.175 kg	2,73 m ³ 2.175 kg
Material weight up to 1,8 t/m ³	2,76 m ³ 2.175 kg	2,76 m ³ 2.175 kg	2,71 m ³ 2.175 kg	2,71 m ³ 2.175 kg	2,38 m ³ 2.000 kg	2,38 m ³ 2.000 kg

PC490-11 / MAX. BUCKET CAPACITY AND WEIGHT

Arm length	SHORT BOOM	
	2,4 m	2,9 m
Material weight up to 1,2 t/m ³	3,50 m ³ 2.450 kg	3,50 m ³ 2.450 kg
Material weight up to 1,5 t/m ³	3,50 m ³ 2.450 kg	3,50 m ³ 2.450 kg
Material weight up to 1,8 t/m ³	3,18 m ³ 2.432 kg	2,95 m ³ 2.308 kg

PC490LC-11 / MAX. BUCKET CAPACITY AND WEIGHT

Arm length	MONO BOOM					
	2,4 m	2,9 m	3,4 m	4,0 m	4,8 m	
Material weight up to 1,2 t/m ³	2,76 m ³ 2.175 kg	2,76 m ³ 2.175 kg	2,76 m ³ 2.175 kg	2,76 m ³ 2.175 kg	2,76 m ³ 2.175 kg	2,76 m ³ 2.175 kg
Material weight up to 1,5 t/m ³	2,76 m ³ 2.175 kg	2,76 m ³ 2.175 kg	2,76 m ³ 2.175 kg	2,76 m ³ 2.175 kg	2,73 m ³ 2.175 kg	2,73 m ³ 2.175 kg
Material weight up to 1,8 t/m ³	2,76 m ³ 2.175 kg	2,76 m ³ 2.175 kg	2,76 m ³ 2.175 kg	2,75 m ³ 2.175 kg	2,38 m ³ 2.000 kg	2,38 m ³ 2.000 kg

PC490LC-11 / MAX. BUCKET CAPACITY AND WEIGHT

Arm length	SHORT BOOM	
	2,4 m	2,9 m
Material weight up to 1,2 t/m ³	3,50 m ³ 2.450 kg	3,50 m ³ 2.450 kg
Material weight up to 1,5 t/m ³	3,50 m ³ 2.450 kg	3,50 m ³ 2.450 kg
Material weight up to 1,8 t/m ³	3,38 m ³ 2.450 kg	3,10 m ³ 2.375 kg

Max. capacity and weight have been calculated according to ISO 10567:2007.

Please consult with your distributor for the correct selection of buckets and attachments to suit the application.

BUCKET AND ARM FORCE

Arm length	2,4 m	2,9 m	3,4 m	4,0 m	4,8 m
Bucket digging force	26.100 kg	26.100 kg	26.100 kg	26.100 kg	26.100 kg
Bucket digging force at PowerMax	28.000 kg	28.000 kg	28.000 kg	28.000 kg	28.000 kg
Arm crowd force	24.200 kg	24.400 kg	20.400 kg	18.100 kg	15.800 kg
Arm crowd force at PowerMax	25.900 kg	26.200 kg	21.800 kg	19.400 kg	17.000 kg

Working Range

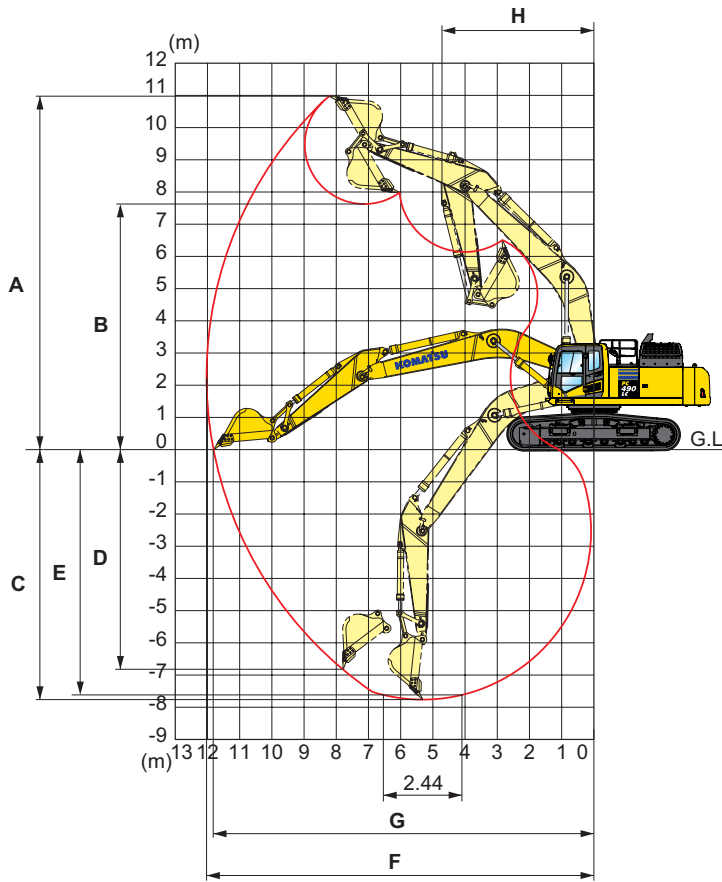

MONO BOOM











ARM LENGTH	2,4 m	2,9 m	3,4 m	4,0 m	4,8 m
A Max. digging height	10.375 mm	10.350 mm	10.980 mm	11.090 mm	11.550 mm
B Max. dumping height	7.135 mm	7.145 mm	7.630 mm	7.780 mm	8.210 mm
C Max. digging depth	6.780 mm	7.280 mm	7.755 mm	8.380 mm	9.190 mm
D Max. vertical wall digging depth	5.240 mm	5.635 mm	6.805 mm	7.220 mm	8.085 mm
E Max. digging depth of cut for 2,44 m level	6.585 mm	7.090 mm	7.615 mm	8.250 mm	9.080 mm
F Max. digging reach	11.080 mm	11.445 mm	12.030 mm	12.565 mm	13.365 mm
G Max. digging reach at ground level	10.840 mm	11.215 mm	11.810 mm	12.355 mm	13.170 mm
H Min. swing radius	4.835 mm	4.810 mm	4.735 mm	4.800 mm	4.885 mm

SHORT BOOM

ARM LENGTH	2,4 m	2,9 m
A Max. digging height	10.510 mm	10.550 mm
B Max. dumping height	7.075 mm	7.115 mm
C Max. digging depth	6.365 mm	6.865 mm
D Max. vertical wall digging depth	4.365 mm	4.950 mm
E Max. digging depth of cut for 2,44 m level	5.630 mm	6.710 mm
F Max. digging reach	10.605 mm	10.985 mm
G Max. digging reach at ground level	10.360 mm	10.750 mm
H Min. swing radius	4.265 mm	4.295 mm

Lifting Capacity

PC490-11 MONO BOOM

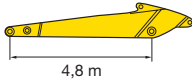
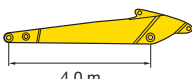
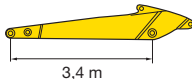
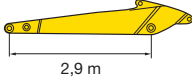
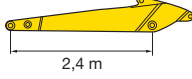
Arm length	A		9,0 m		7,5 m		6,0 m		4,5 m		3,0 m			
	B													
	7,5 m	kg	*6.370	*6.370	*9.480	9.310								
	6,0 m	kg	*6.300	*6.300	*9.820	9.180								
	4,5 m	kg	*6.370	6.290	*10.440	8.940	*11.480	*11.480						
	3,0 m	kg	*6.570	6.040	*11.170	8.660	*12.760	11.240	*15.370	*15.370	*20.330	*20.330		
	1,5 m	kg	*6.910	5.950	11.300	8.390	*13.960	10.770	*17.410	14.630	*23.980	22.090		
	0,0 m	kg	*7.450	6.020	11.050	8.150	14.260	10.390	*18.740	14.030	*24.610	21.150	*10.120	*10.120
	-1,5 m	kg	*8.260	6.270	10.880	7.990	14.000	10.140	*19.160	13.680	*25.780	20.750	*13.950	*13.950
	-3,0 m	kg	*9.180	6.790	10.820	7.940	13.880	10.040	*18.660	13.560	*24.560	20.690	*18.840	*18.840
	-4,5 m	kg	*9.990	7.740	*10.610	8.020	*13.580	10.080	*17.100	13.620	*22.080	20.870	*25.120	*25.120
	-6,0 m	kg	*9.580	*9.580			*10.700	10.320	*14.070	13.890	*17.970	*17.970	*23.550	*23.550
	7,5 m	kg	*7.880	*7.880	*9.970	9.150								
	6,0 m	kg	*7.820	7.630	*10.720	9.060	*11.480	*11.480						
	4,5 m	kg	*7.940	7.050	*11.240	8.860	*12.520	11.550	*14.620	*14.620				
	3,0 m	kg	*8.250	6.740	11.540	8.620	*13.690	11.120	*16.750	15.170	*22.810	*22.810		
	1,5 m	kg	*8.780	6.640	11.290	8.390	14.600	10.720	*18.460	14.470	*23.800	21.680		
	0,0 m	kg	9.060	6.750	11.100	8.210	14.280	10.420	*19.320	14.020	*22.690	21.110		
	-1,5 m	kg	9.560	7.100	10.990	8.110	14.100	10.250	*19.230	13.800	*25.360	20.950	*15.150	*15.150
	-3,0 m	kg	10.560	7.810	11.010	8.130	14.070	10.220	*18.170	13.780	*23.390	21.050	*21.760	*21.760
	-4,5 m	kg	*10.710	9.200			*12.490	10.360	*15.910	13.940	*20.120	*20.120	*25.940	*25.940
	-6,0 m	kg	*9.760	*9.760					*11.580	*11.580	*14.840	*14.840		
	7,5 m	kg	*9.140	*9.140		*11.710	*11.710							
	6,0 m	kg	*9.040	8.290	*11.420	8.970	*12.310	11.800						
	4,5 m	kg	*9.190	7.620	11.740	8.820	*13.280	11.450	*15.730	*15.730	*20.530	*20.530		
	3,0 m	kg	*9.560	7.270	11.520	8.620	*14.340	11.060	*17.720	15.010	*24.590	22.490		
	1,5 m	kg	9.590	7.170	11.320	8.420	14.600	10.720	*19.130	14.420	*17.760	*17.760		
	0,0 m	kg	9.820	7.320	11.170	8.290	14.340	10.480	*19.600	14.080	*20.720	*20.720		
	-1,5 m	kg	10.450	7.770	11.120	8.240	14.220	10.370	*19.100	13.950	*24.620	21.230	*15.450	*15.450
	-3,0 m	kg	*11.400	8.690			*14.020	10.400	*17.580	14.000	*22.140	21.400	*24.050	*24.050
	-4,5 m	kg	*10.880	10.560			*11.020	10.640	*14.650	14.230	*18.250	*18.250	*22.170	*22.170
	-6,0 m	kg												
	7,5 m	kg	*12.150	10.610		*12.310	11.810							
	6,0 m	kg	*11.930	9.070		*12.790	11.620	*14.530	*14.530					
	4,5 m	kg	10.980	8.230	11.600	8.680	*13.680	11.280	*16.380	15.470				
	3,0 m	kg	10.440	7.800	11.410	8.500	*14.630	10.910	*18.200	14.750				
	1,5 m	kg	10.320	7.690	11.230	8.340	14.460	10.590	*19.330	14.220				
	0,0 m	kg	10.610	7.870	11.110	8.230	14.240	10.390	*19.460	13.940				
	-1,5 m	kg	11.420	8.440			14.170	10.330	*18.630	13.890	*23.440	21.190		
	-3,0 m	kg	*12.110	9.630			*13.280	10.410	*16.740	14.000	*20.660	*20.660	*24.100	*24.100
	-4,5 m	kg	*11.370	*11.370					*13.180	*13.180	*16.280	*16.280		
	-6,0 m	kg												
	7,5 m	kg	*11.060	10.910		*13.240	11.760							
	6,0 m	kg	*10.630	9.330		*13.540	11.630	*15.500	*15.500					
	4,5 m	kg	*10.570	8.490	11.660	8.760	*14.340	11.340	*17.310	15.450				
	3,0 m	kg	10.770	8.080	11.510	8.620	14.890	11.010	*18.990	14.800				
	1,5 m	kg	10.690	8.000	11.380	8.490	14.610	10.750	*19.810	14.370				
	0,0 m	kg	11.040	8.240	11.310	8.430	14.440	10.590	*19.580	14.190				
	-1,5 m	kg	11.940	8.880			14.420	10.570	*18.400	14.190	*22.330	21.690		
	-3,0 m	kg	*11.380	10.220			*12.470	10.720	*16.070	14.340	*19.340	*19.340	*20.410	*20.410
	-4,5 m	kg	*9.680	*9.680					*11.510	*11.510	*14.400	*14.400		
	-6,0 m	kg												

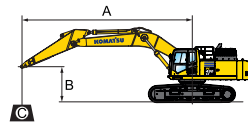

A – Reach from swing center
 B – Bucket hook height
 C – Lifting capacities











 – Rating over front
 – Rating over side
 – Rating at maximum reach

With 600 mm shoes

Weights:
 Bucket linkage and bucket cylinder: 490 kg

PC490/490LG-11

PC490-11 SHORT BOOM

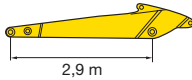
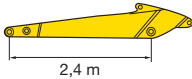
Arm length	A		9,0 m		7,0 m		6,0 m		4,5 m		3,0 m			
	B													
	6,0 m	kg	*12.660	9.390		*13.750	12.610	*14.950	*14.950					
	4,5 m	kg	11.440	8.470	11.440	8.470	*14.750	12.240	*16.640	15.290	*21.690	*21.690		
	3,0 m	kg	10.850	8.010			*15.840	11.810	*18.380	14.600				
	1,5 m	kg	10.730	7.900			15.890	11.440	*19.480	14.070				
	0,0 m	kg	11.070	8.110			15.640	11.210	*19.560	13.770	*25.650	20.810		
	-1,5 m	kg	12.010	8.760			15.560	11.140	*18.520	13.700	*23.550	20.870	*20.560	*20.560
	-3,0 m	kg	*12.030	10.150			*13.660	11.250	*16.160	13.830	*20.180	*20.180	*23.870	*23.870
-4,5 m	kg	*10.620	*10.620					*11.420	*11.420	*14.740	*14.740			
	6,0 m	kg	*13.690	10.170		*14.570	12.600	*15.930	15.840					
	4,5 m	kg	12.300	9.120		*15.480	12.270	*17.560	15.260					
	3,0 m	kg	11.640	8.620			16.360	11.890	*19.140	14.650				
	1,5 m	kg	11.530	8.510			16.030	11.590	*19.940	14.210				
	0,0 m	kg	11.950	8.790			15.840	11.420	*19.650	14.010				
	-1,5 m	kg	*12.910	9.590			*15.600	11.400	*18.200	14.000	*22.490	21.330		
	-3,0 m	kg	*12.110	11.330			*12.550	11.590	*15.260	14.180	*18.700	*18.700	*20.230	*20.230
-4,5 m	kg													

* Load is limited by hydraulic capacity rather than tipping. Ratings are based on SAE Standard No. J1097. Rated loads do not exceed 87% of hydraulic lift capacity or 75% of tipping load. Lifting capacity stated is based on lifting with bare arm. When lifting with additional equipment installed to the arm, please subtract the weight of all additional equipment from the values stated.

PC490LC-11 MONO BOOM

Arm length	A		9,0 m		7,5 m		6,0 m		4,5 m		3,0 m	
	B											
 4,8 m	7,5 m	kg *6.370	*6.370	*9.480	9.460							
	6,0 m	kg *6.300	*6.300	*9.820	9.320							
	4,5 m	kg *6.370	*6.370	*10.440	9.090	*11.480	*11.480					
	3,0 m	kg *6.570	6.140	*11.170	8.810	*12.760	11.420	*15.370	*15.370	*20.330	*20.330	
	1,5 m	kg *6.910	6.050	*11.870	8.530	*13.960	10.950	*17.410	14.880	*23.980	22.460	
	0,0 m	kg *7.450	6.130	12.350	8.300	*14.820	10.570	*18.740	14.270	*24.610	21.510	*10.120
	-1,5 m	kg *8.260	6.390	12.180	8.140	*15.160	10.330	*19.160	13.930	*25.780	21.120	*13.950
	-3,0 m	kg *9.540	6.910	*12.080	8.080	*14.830	10.220	*18.660	13.800	*24.560	21.060	*18.840
	-4,5 m	kg *9.990	7.880	*10.610	8.160	*13.580	10.260	*17.100	13.870	*22.080	21.240	*25.120
	-6,0 m	kg *9.580	*9.580			*10.700	10.510	*14.070	*14.070	*17.970	*17.970	*23.550
 4,0 m	7,5 m	kg *7.880	*7.880	*9.970	9.290							
	6,0 m	kg *7.820	7.750	*10.720	9.200	*11.480	*11.480					
	4,5 m	kg *7.940	7.170	*11.240	9.010	*12.520	11.730	*14.620	*14.620			
	3,0 m	kg *8.250	6.860	*11.860	8.770	*13.690	11.300	*16.750	15.410	*22.810	*22.810	
	1,5 m	kg *8.780	6.760	*12.410	8.540	*14.690	10.900	*18.460	14.710	*23.800	22.050	
	0,0 m	kg *9.600	6.870	12.400	8.360	*15.290	10.600	*19.320	14.260	*22.690	21.470	
	-1,5 m	kg 10.660	7.230	12.290	8.260	*15.280	10.430	*19.230	14.040	*25.360	21.320	*15.150
	-3,0 m	kg *10.920	7.950	*11.560	8.270	*14.500	10.400	*18.170	14.020	*23.390	21.410	*21.760
	-4,5 m	kg *10.710	9.360			*12.490	10.540	*15.910	14.180	*20.120	*20.120	*25.940
	-6,0 m	kg *9.760	*9.760					*11.580	*11.580	*14.840	*14.840	
 3,4 m	7,5 m	kg *9.140	*9.140			*11.710	*11.710					
	6,0 m	kg *9.040	8.430	*11.420	9.120	*12.310	11.980					
	4,5 m	kg *9.190	7.750	*11.820	8.960	*13.280	11.640	*15.730	*15.730	*20.530	*20.530	
	3,0 m	kg *9.560	7.390	*12.340	8.760	*14.340	11.250	*17.720	15.260	*24.590	22.860	
	1,5 m	kg *10.220	7.300	12.620	8.570	*15.180	10.900	*19.130	14.660	*17.760	*17.760	
	0,0 m	kg 10.930	7.450	12.470	8.430	*15.540	10.660	*19.600	14.320	*20.720	*20.720	
	-1,5 m	kg *11.510	7.910	*12.360	8.380	*15.240	10.560	*19.100	14.200	*24.620	21.590	*15.450
	-3,0 m	kg *11.400	8.840			*14.020	10.590	*17.580	14.250	*22.140	21.770	*24.050
	-4,5 m	kg *10.880	10.740			*11.020	10.820	*14.650	14.480	*18.250	*18.250	*22.170
	-6,0 m	kg										
 2,9 m	7,5 m	kg *12.150	10.780			*12.310	11.990					
	6,0 m	kg *11.930	9.220			*12.790	11.800	*14.530	*14.530			
	4,5 m	kg *11.890	8.370	*12.130	8.830	*13.680	11.460	*16.380	15.720			
	3,0 m	kg 11.630	7.940	*12.530	8.650	*14.630	11.090	*18.200	14.990			
	1,5 m	kg 11.510	7.820	12.530	8.480	*15.310	10.770	*19.330	14.460			
	0,0 m	kg 11.840	8.010	12.410	8.370	*15.480	10.570	*19.460	14.190			
	-1,5 m	kg *12.250	8.590			*14.920	10.510	*18.630	14.130	*23.440	21.560	
	-3,0 m	kg *12.110	9.800			*13.280	10.600	*16.740	14.240	*20.660	*20.660	*24.100
	-4,5 m	kg *11.370	*11.370					*13.180	*13.180	*16.280	*16.280	
	-6,0 m	kg										
 2,4 m	7,5 m	kg *11.060	*11.060			*13.240	11.940					
	6,0 m	kg *10.630	9.480			*13.540	11.810	*15.500	*15.500			
	4,5 m	kg *10.570	8.630	*12.710	8.900	*14.340	11.520	*17.310	15.690			
	3,0 m	kg *10.810	8.220	12.820	8.770	*15.180	11.190	*18.990	15.050			
	1,5 m	kg *11.370	8.140	12.680	8.640	*15.710	10.930	*19.810	14.620			
	0,0 m	kg 12.300	8.380	12.610	8.570	*15.660	10.780	*19.580	14.430			
	-1,5 m	kg *12.040	9.040			*14.790	10.750	*18.400	14.430	*22.330	22.050	
	-3,0 m	kg *11.380	10.400			*12.470	10.910	*16.070	14.590	*19.340	*19.340	*20.410
	-4,5 m	kg *9.680	*9.680					*11.510	*11.510	*14.400	*14.400	
	-6,0 m	kg										

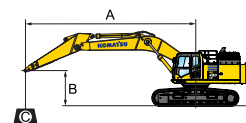

A – Reach from swing center

B – Bucket hook height

C – Lifting capacities

– Rating over front

– Rating over side

– Rating at maximum reach

With 600 mm shoes

Weights:

Bucket linkage and bucket cylinder: 490 kg

PC490LC-11 SHORT BOOM

Arm length	A		9,0 m		7,0 m		6,0 m		4,5 m		3,0 m	
	B											
 2,9 m	6,0 m	kg *12.660	9.550			*13.750	12.810	*14.950	*14.950			
	4,5 m	kg *12.530	8.610	*12.530	8.610	*14.750	12.430	*16.640	15.530	*21.690	*21.690	
	3,0 m	kg 12.100	8.150			*15.840	12.000	*18.380	14.840			
	1,5 m	kg 11.980	8.030			*16.600	11.640	*19.480	14.310			
	0,0 m	kg 12.370	8.260			*16.690	11.410	*19.560	14.010	*25.650	21.170	
	-1,5 m	kg *12.460	8.920			*15.860	11.340	*18.520	13.940	*23.550	21.230	*20.560
	-3,0 m	kg *12.030	10.330			*13.660	11.450	*16.160	14.070	*20.180	*20.180	*23.870
	-4,5 m	kg *10.620	*10.620					*11.420	*11.420	*14.740	*14.740	
 2,4 m	6,0 m	kg *13.690	10.340			*14.570	12.800	*15.930	*15.930			
	4,5 m	kg *13.450	9.270			*15.480	12.470	*17.560	15.500			
	3,0 m	kg 12.970	8.760			*16.440	12.090	*19.140	14.890			
	1,5 m	kg 12.860	8.660			*17.000	11.790	*19.940	14.450			
	0,0 m	kg *13.200	8.940			*16.810	11.620	*19.650	14.250			
	-1,5 m	kg *12.910	9.750			*15.600	11.600	*18.200	14.240	*22.490	21.690	
-3,0 m	kg *12.110	11.520			*12.550	11.780	*15.260	14.420	*18.700	*18.700	*20.230	
-4,5 m	kg											

* Load is limited by hydraulic capacity rather than tipping. Ratings are based on SAE Standard No. J1097. Rated loads do not exceed 87% of hydraulic lift capacity or 75% of tipping load. Lifting capacity stated is based on lifting with bare arm. When lifting with additional equipment installed to the arm, please subtract the weight of all additional equipment from the values stated.

Standard and Optional Equipment

ENGINE

Komatsu SAA6D125E-7 turbocharged common rail direct injection diesel engine	●
EU Stage V compliant	●
Remote hydraulically driven, variable speed, reversible cooling fan	●
Automatic engine warm-up system	●
Engine overheat prevention system	●
Fuel control dial	●
Auto-deceleration function	●
Adjustable idle shutdown	●
Engine key stop	●
Engine ignition can be password secured on request	●
Alternator 24 V/90 A	●
Starter motor 24 V/11 kW	●
Batteries 2 × 12 V/180 Ah	●

HYDRAULIC SYSTEM

Electronic closed-centre load sensing (E-CLSS) hydraulic system (HydrauMind)	●
Pump and engine mutual control (PEMC) system	●
6-working mode selection system; Power mode, Economy mode, Breaker mode, Attachment Power and Attachment Economy mode, and Lifting/Fine Operation mode	●
PowerMax function	●
PPC wrist control levers for arm, boom, bucket and swing, with sliding proportional control for attachments and 3 auxiliary buttons	●
Two-mode boom control	●
Prepared for hydraulic quick-coupler	●
Additional hydraulic functions	○
Komatsu Integrated Attachment Control (KIAC)	○

DRIVES AND BRAKES

Hydrostatic, 3-speed travel system with automatic shift and planetary gear type final drives, and hydraulic travel and parking brakes	●
PPC control levers and pedals for steering and travel	●

UNDERCARRIAGE

Track roller guards	●
Track frame under-guards	●
600, 700, 800, 900 mm triple grouser shoes	○
600 mm double grouser shoes	○
Full length track roller guards	○

CABIN

Reinforced safety SpaceCab™; highly pressurised and tightly sealed hyper viscous mounted cab with tinted safety glass windows, large roof window with sun shade, pull-up type front window with locking device, removable lower window, front window wiper with intermittent feature, sun roller blind, cigarette lighter, ashtray, luggage shelf, floor mat	●
Heated, high-back air-suspended seat with lumbar support, console mounted height adjustable arm rests, and retractable seat belt	●
Automatic climate control system	●
12/24 Volt power supplies	●
Beverage holder and magazine rack	●
Hot and cool box	●
Radio (AM/FM)	●
Auxiliary input (MP3 jack)	●
Lower wiper	○
Rain visor (not with OPG)	○
DAB+ digital radio w. auxiliary input (MP3 jack)	○

SERVICE AND MAINTENANCE

Automatic fuel line de-aeration	●
Double element type air cleaner with dust indicator and auto dust evacuator	●
KOMTRAX – Komatsu wireless monitoring system (3G)	●
Komatsu CARE™ – a maintenance program for Komatsu customers	●
Multifunction video compatible colour monitor with Equipment Management and Monitoring System (EMMS) and efficiency guidance	●
Toolkit	●
Service points	○
Automatic greasing system	○

WORK EQUIPMENT

Mono boom (7,1 m)	○
Short boom (6,7 m)	○
2,4 m; 2,9 m; 3,4 m; 4,0 m; 4,8 m arms	○
Komatsu buckets	○
Komatsu breakers	○

SAFETY EQUIPMENT

KomVision surround view system	●
Electric horn	●
Overload warning device	●
Audible travel alarm	●
Boom safety valves	●
Large handrails, rear-view mirrors	●
Battery main switch	●
ROPS compliant to ISO 12117-2:2008	●
Emergency engine stop switch	●
Seat belt caution indicator	●
Neutral position detection system	●
Arm safety valve	●
OPG Level II front guard (FOPS), hinged type	○
OPG Level II top guard (FOPS)	○

LIGHTING SYSTEM

Working lights: 2 revolving frame, 1 boom (l.h.)	●
Additional working lights: 4 cab roof (front), 1 cab roof (rear), 1 boom (r.h.), 1 counterweight (rear), beacon	○
LED working lights: 2 revolving frame (halogen), 2 boom (LED, l.h. & r.h.), 2 boom cylinders (LED), 4 cab roof (LED, front), 1 cab roof (halogen, rear), 2 counterweight (halogen, rear), 1 right side machine (halogen), beacon	○

OTHER EQUIPMENT

Standard counterweight	●
Remote greasing for swing circle and pins	●
Electric refuelling pump with automatic shut-off function	●
Biodegradable oil for hydraulic system	○
Customised paint	○

Further equipment on request

- standard equipment
- optional equipment

Your Komatsu partner:

KOMATSU

**Komatsu Europe
International N.V.**

Mechelsesteenweg 586
B-1800 VILVOORDE (BELGIUM)
Tel. +32-2-255 24 11
Fax +32-2-252 19 81
www.komatsu.eu

UENSS17208 03/2020

KOMATSU is a trademark of Komatsu Ltd. Japan.

PG490/490LG-11