

# KOMATSU

## PW180-11

EU Stage IV Engine

### HYDRAULIC WHEELED EXCAVATOR



PW180

**ENGINE POWER**

123 kW / 165 HP @ 2.000 rpm

**OPERATING WEIGHT**

17.600 - 20.600 kg

**BUCKET CAPACITY**

max. 1,13 m<sup>3</sup>

# Walk-Around

PW180-11



**ENGINE POWER**

123 kW / 165 HP @ 2.000 rpm

**OPERATING WEIGHT**

17.600 - 20.600 kg

**BUCKET CAPACITY**

max. 1,13 m<sup>3</sup>



## EXCEPTIONAL WORKABILITY AND ENVIRONMENTAL PERFORMANCE

### ***Powerful and environmentally friendly***

- EU Stage IV engine
- Adjustable idle shutdown
- Komatsu fuel-saving technology
- Excellent travel performance
- High lifting capacity

### ***Total versatility***

- Ideal for a wide range of applications
- Additional hydraulic circuit
- Komatsu Integrated Attachment Control (KIAC)
- A wide choice of options

### ***First-class operator comfort***

- Premium air-suspended operator seat with integrated joystick consoles (option)
- Boom suspension system (ECSS)
- KomVision surround view system
- Improved widescreen monitor
- Optional joystick steering system

### ***State-of-the-art controls***

- Proportional controls for attachments
- Improved, ergonomic switches
- 6 working modes

### ***Easy maintenance***

- Improved service access
- Extended undercarriage maintenance interval
- Centralised greasing system
- User-friendly location of the electric refuelling pump
- Simple access to the AdBlue® tank

### ***KOMTRAX***

- Komatsu Wireless Monitoring System
- 3G mobile communications
- Increased operational data and fuel savings
- Integrated communication antenna



A maintenance program  
for Komatsu customers

# Powerful and Environmentally Friendly



## Higher productivity

Along with its compact size, the PW180-11 features an unrivalled lifting performance. The combination of power, weight distribution, convenient dimensions and complete control makes it the top choice for heavy-duty lifting applications, simple excavating tasks in narrow alleys, and for road and sewer construction sites.

## Komatsu fuel-saving technology

Fuel consumption on the PW180-11 is lower by up to 3%. Engine management is enhanced. The variable speed matching of the engine and hydraulic pumps guarantee efficiency and precision during single and combined movements. A viscous clutch enables variable cooling fan speed to further reduce fuel consumption.

## Adjustable idle shutdown

The Komatsu auto idle shutdown automatically turns off the engine after it idles for a set period of time. This feature can easily be programmed from 5 to 60 minutes, to reduce unnecessary fuel consumption and exhaust emissions, and to lower operating costs. An Eco-gauge and the Eco guidance tips on the cab monitor further encourage efficient operations.

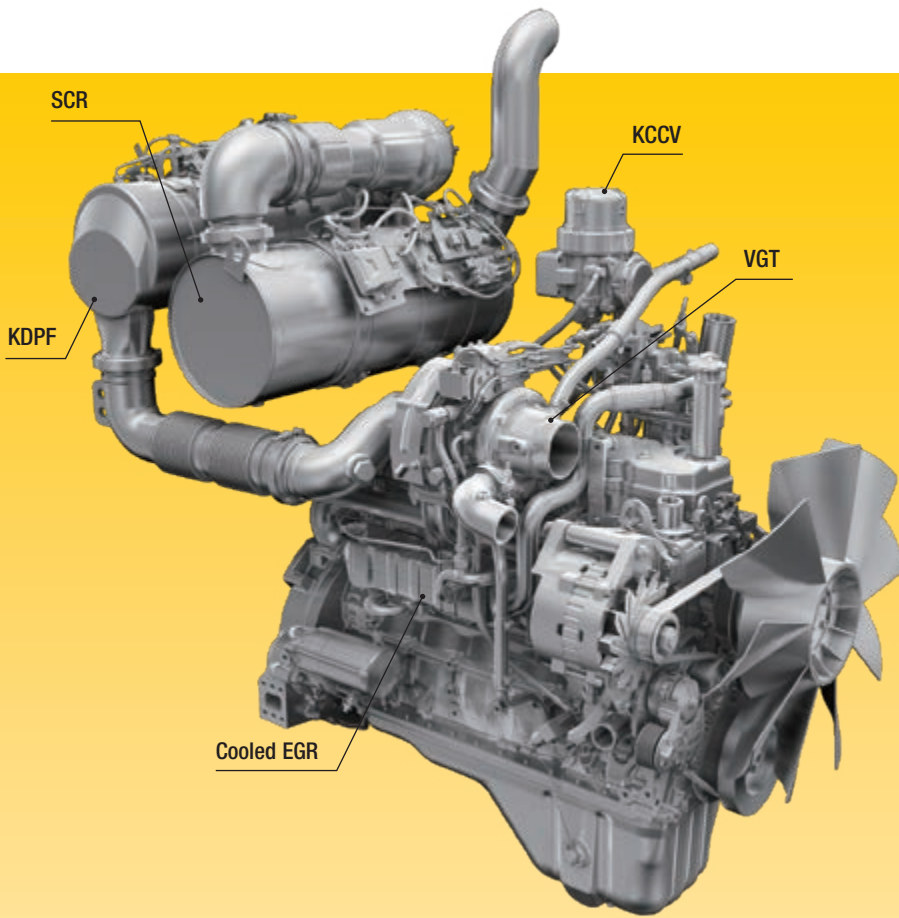

## Komatsu EU Stage IV

The Komatsu EU Stage IV engine is productive, dependable and efficient. With ultra-low emissions, it provides a lower environmental impact and a superior performance to help reduce operating costs and lets the operator work in complete peace of mind.

## Heavy-duty aftertreatment

The aftertreatment system combines a Komatsu Diesel Particulate Filter (KDPF) and Selective Catalytic Reduction (SCR). The SCR injects the correct amount of AdBlue® into the system at the proper rate to break down NOx into water (H<sub>2</sub>O) and non-toxic nitrogen gas (N<sub>2</sub>). NOx emissions are reduced by 80% vs. EU Stage IIIB engines.

### Exhaust Gas Recirculation (EGR)

Cooled EGR is a technology well-proven in current Komatsu engines. The increased capacity of the EGR cooler now ensures very low NOx emissions and a better engine performance.

### Komatsu Closed Crankcase Ventilation (KCCV)

Crankcase emissions (blow-by gas) are passed through a CCV filter. The oil mist trapped in the filter is returned back to the crankcase while the filtered gas is returned to the air intake.

### High-Pressure Common Rail (HPCR)

To achieve complete fuel burn and lower exhaust emissions, the heavy-duty High-Pressure Common Rail fuel injection system is computer controlled to deliver a precise quantity of pressurised fuel into the redesigned engine combustion chamber by multiple injections.

### Variable Geometry Turbo (VGT)

The VGT provides optimal airflow to the engine combustion chamber under all speed and load conditions. Exhaust gas is cleaner, fuel economy is improved while machine power and performance are maintained.

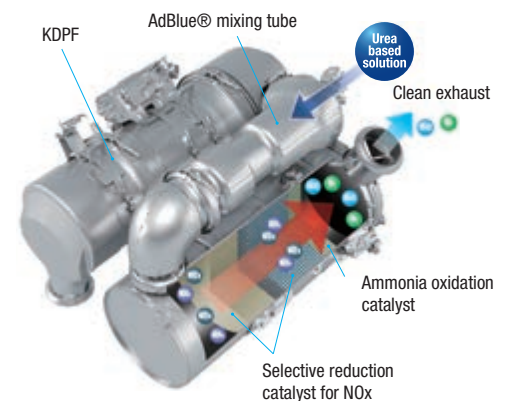

Eco-gauge, Eco guidance and fuel consumption gauge

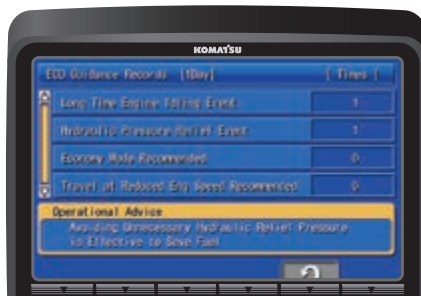

ECO guidance record

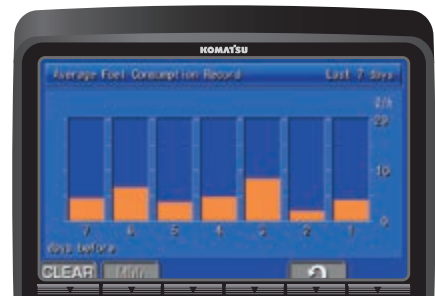

Fuel consumption history

# Total Versatility

## Ideal for a wide range of applications

Powerful and precise, the Komatsu PW180-11 is equipped to efficiently carry out any task your business requires. On big sites or small, for digging, trenching, landscaping or site preparation, the Komatsu original equipment hydraulic system always ensures maximum productivity and control.

## Additional hydraulic circuit

To allow the use of many attachments, such as buckets, breakers or clamshell buckets, an additional hydraulic circuit controlled by a sliding joystick button is standard on the PW180-11. To further increase versatility and flexibility, a second optional auxiliary circuit and an optional hydraulic quick-coupler actuation are also available. In combination with the Komatsu Integrated Attachment Control (KIAC), changing and operating different attachments becomes child's play.

## Trailer hitch

For increased versatility, the PW180-11 can be equipped with either a car ball type hitch, an agricultural ball type hitch, or a truck type automatic hitch, for trailers up to 7,5 tonnes with an overrun brake. All necessary electric and hydraulic hook-ups are provided, including two auxiliary undercarriage circuits for dumping or tail-gate operation. These trailer functions can be operated from the cab joysticks.



*Different trailer hitches are available*

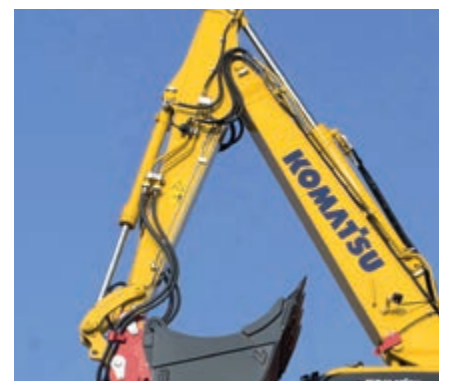

*New HCU piping layout with a unified design for all arm lengths*

PW180-11



Lehnhoff quick-couplers – mechanical, hydraulic or fully hydraulic – are now available for factory installation. They can turn an excavator into a multi-functional tool carrier for any type of attachment. All quick-couplers offer high functional safety thanks to their sealed locking mechanisms and hydraulics. Load hooks are standard on all models. Customers benefit from Komatsu quality optimized piping layout and hose routing and from a 24 months factory warranty.



**Mechanical quick-coupler MS10**  
Durable and reliable even in heavy-duty operations. Locked by turning a socket wrench, safely locked over dead point.



**Fully hydraulic quick-coupler Variolock VL100**  
The operator can comfortably change attachments including hydraulic connections from the cab in a matter of seconds, without having to leave the cab and without depending on other personnel. Leads to increased productivity and encourages the operator to use the right tool for the job. It also helps to prevent hose ruptures and contamination of the hydraulic system and of the environment.



**Hydraulic quick-coupler HS10**  
Convenient, quick and safe locking from driver's cab. Locked hydraulically by a double-acting cylinder.

# First-Class Comfort



## Increased comfort

The SpaceCab™ provides an ergonomic and quiet work environment, with an outstanding view of the jobsite. ROPS certified, it was specifically designed by Komatsu for hydraulic excavators, with a reinforced pipe-structured framework set up on viscous damper mounts for low vibration levels. The standard telescopic steering wheel is comfortably adjustable in height and reach.

## Low-noise design

Komatsu wheeled excavators have very low external noise levels and are especially well-suited for work in confined spaces or urban areas. The optimal usage of sound insulation and of sound absorbing materials helps to make noise levels inside the cab comparable to those of an executive car.

## Premium comfort seat (option)

The premium comfort seat comes with suspended joystick consoles, top quality cushioning, auto weight adjustment, pneumatic lumbar support and a climate control system for perfect seat temperature adjustment.

## Improved operator convenience

With increased in-cab storage space, an auxiliary input (MP3 jack) and 12 V and 24 V power supply, the cab offers maximum convenience. The automatic air conditioner allows the operator to easily and precisely set the cab's atmosphere.

## Boom suspension system (ECSS)

A boom suspension system (ECSS) provides a significant increase in comfort when travelling over bumps.



*New premium comfort seat*



*Boom suspension system (ECSS) for increased travel comfort*



# State-of-the-Art Controls

## Easy operation

The Komatsu PW180-11 features an operational concept that puts full control of the machine right at the operator's fingertips. Different camera views, undercarriage attachments and the manual axle lock can all be actuated by buttons on top of the operational levers. Without removing the hand from the joystick, the operator can switch from boom operation to undercarriage control for complete and precise control over the parallel dozer blade.

## Proportional controls

The ergonomic joysticks with proportional controls were specially redesigned and developed for working with a wheeled excavator. They have horizontal sliders for the first and second (optional) hydraulic circuits and offer safe and precise operation of attachments such as ditch cleaning buckets, sorting grapples, clamshell buckets, tilt rotators and of many other hydraulic attachments that require very fine control.

## Komatsu Integrated Attachment Control (KIAC) (option)

For fast and safe tool changes without leaving the cab, the settings for oil flow and pressure of up to 15 hydraulic attachments are available as presets directly on the monitor panel. Komatsu Integrated Attachment Control (KIAC) includes adjustments for the first and second (optional) hydraulic circuits. Selecting the breaker mode automatically cuts all pressure in the return line.

## 6 working modes

The PW180-11 delivers the required power with the lowest fuel consumption. 6 working modes are available: Power, Lifting/Fine Operation, Breaker, Economy, Attachment Power and Attachment Economy. The operator can ideally balance the Economy mode between power and economy to match the work at hand.



*Komatsu Integrated Attachment Control (KIAC)*



*Adjustable oil flow*



*Ergonomically designed switches that light up for safe and easy night operation*



*For frequent steering, the Adjustable Joystick Steering option allows to control the machine with less effort*

# Information & Communication Technology



## Lower operating costs

Komatsu ICT contributes to the reduction of operating costs by assisting to comfortably and efficiently manage operations. It raises the level of customer satisfaction and the competitive edge of our products.

## Widescreen monitor

Installed with a choice of 24 languages, the widescreen monitor with simple switches and multifunction keys gives fingertip access to a large range of functions and operating info.

## An evolutionary interface

Helpful information is now easier than ever to find and understand with the upgraded monitor interface. An optimal main screen for the ongoing work can be selected simply by pressing the F6 key.

Operation Records (1Day)	
Working Hours (Energy DO)	0.2 h
Average Fuel Consumption	7.2 l/h
Actual Working Hours	0.1 h
Ave Fuel Consumption (Actual Working)	7.2 l/h
Fuel Consumption	7 l
Idling Hours	0.1 h

Quick view on the operation logs



With KomVision, various camera view options help to maintain a constant bird's eye view from above the machine

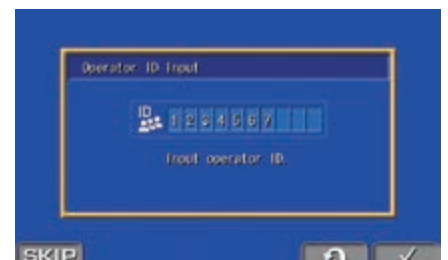

Operator identification function

# Safety First



## Optimal jobsite safety

Safety features on the Komatsu PW180-11 comply with the latest industry standards and work in synergy to minimise risks to people in and around the machine. A neutral detection system for travel and work equipment levers increase jobsite safety, along with a seat belt caution indicator and an audible travel alarm. Highly durable anti-slip plates – with additional high friction covering – maintain long term traction performance.



*KomVision cameras*



*Exceptional operator protection*



*Straight ladder for service access, handrails and anti-slip plates*

## KomVision

With a series of high definition networked cameras fitted on the machine, KomVision provides a crystal clear, real-time bird's eye view of the immediate surroundings on the wide-screen cab monitor. The operator can quickly and easily check the machine's vicinity prior to making any movement, and focus on the work at hand even in low light conditions.

## Komatsu SpaceCab™

The ROPS cab has a tubular steel frame and provides high shock absorbency, impact resistance and durability. The seat belt is well designed to keep the operator in the safety zone of the cab in the event of a rollover. Optionally the cab can be fitted with a Falling Object Protective System (FOPS) with openable front guard.

## Safe maintenance

Thermal guards around high temperature areas of the engine, protected fan belt and pulleys, a pump/engine partition that prevents hydraulic oil from spraying onto the engine, and exceptionally sturdy handrails: in Komatsu tradition, the highest safety level is provided for a fast and smooth maintenance.

# Easy Maintenance



## Simple and convenient service

The large doors and engine hood give convenient access to all daily service points. Filters are centralised and required service intervals are longer to keep machine downtime to a minimum.

## Komatsu CARE™

Komatsu CARE™ is a maintenance program that comes as standard with your new Komatsu machine. It covers factory-scheduled maintenance, performed with Komatsu Genuine parts by Komatsu-trained technicians. Depending on your machine's engine, it also offers extended coverage of the Komatsu Diesel Particulate Filter (KDPF) or the Komatsu Diesel Oxidation Catalyst (KDOC), and of the Selective Catalytic Reduction (SCR). Please contact your local Komatsu distributor for terms and conditions.



## Easy radiator access

Thanks to a side-by-side cooler arrangement, the aftercooler and hydraulic oil radiator can be cleaned easily and repaired individually in case of damage.

## Electric refuelling pump

Standard equipment on all PW180-11 includes an automatic shut-off fuelling pump that allows easy refuelling from a barrel.

## Remote greasing bar

The PW180-11 features a centralised system that facilitates the regular greasing of the boom. An optional fully automatic greasing system can handle the regular and proper greasing of the complete machine – prolonging the lifetime and increasing the resale value of the excavator.

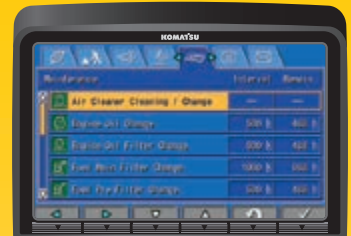

Basic maintenance screen

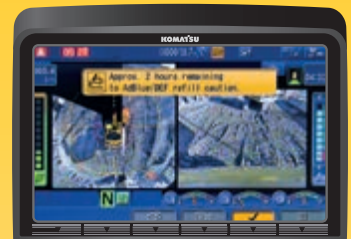

AdBlue® level and refill guidance



Simple access to the AdBlue® tank



Automatic greasing system (option)



PW180-11

# KOMTRAX

## The way to higher productivity

KOMTRAX uses the latest wireless monitoring technology. Compatible on PC, smartphone or tablet, it delivers insightful and cost saving information about your fleet and equipment, and offers a wealth of information to facilitate peak machine performance. By creating a tightly integrated web of support it allows proactive and preventive maintenance and helps to efficiently run a business.



## Knowledge

You get quick answers to basic and critical questions about your machines – what they're doing, when they did it, where they're located, how they can be used more efficiently and when they need to be serviced.

Performance data is relayed by wireless communication technology (satellite, GPRS or 3G depending on model) from the machine to a computer and to the local Komatsu distributor – who's readily available for expert analysis and feedback.

## Power

The detailed information that KOMTRAX puts at your fingertips 24 hours a day, 7 days a week gives the power to make better daily and long-term strategic decisions – at no extra cost. Problems can be anticipated, maintenance schedules customised, downtime minimised and machines kept where they belong: working on the jobsite.

## Convenience

KOMTRAX enables convenient fleet management on the web, wherever you are. Data is analysed and packaged specifically for effortless and intuitive viewing in maps, lists, graphs and charts. You can foresee eventual maintenance issues and required spare parts, and troubleshoot a problem before Komatsu technicians arrive on site.



# Specifications

## ENGINE

Model	Komatsu SAA6D107E-3
Type	Common rail direct injection, water-cooled, emissionised, turbocharged, after-cooled diesel
Engine power	
at rated engine speed	2.000 rpm
ISO 14396	123 kW / 165 HP
ISO 9249 (net engine power)	118 kW / 158 HP
No. of cylinders	6
Bore × stroke	107 × 124 mm
Displacement	6,69 l
Air filter type	Double element type with monitor panel dust indicator and auto dust evacuator
Cooling	Suction type cooling fan with radiator fly screen
Alternator	24 V / 90 A
Starter motor	24 V / 5,5 kW

## HYDRAULIC SYSTEM

Type	HydrauMind. Closed-centre system with load sensing and pressure compensation valves
Additional circuits	Depending on the specification up to 2 additional proportional control & quick coupler circuits can be installed
Main pump	Variable displacement piston pump supplying boom, arm, bucket, swing and travel circuits
Maximum pump flow	288,4 l/min
Relief valve settings	
Implement	380 kg/cm <sup>2</sup>
Travel	420 kg/cm <sup>2</sup>
Swing	290 kg/cm <sup>2</sup>
Pilot circuit	36 kg/cm <sup>2</sup>

## SWING SYSTEM

Type	Axial piston motor driving through planetary double reduction gearbox
Swing lock	Electrically actuated wet multi-disc brake integrated into swing motor
Swing speed	0 - 11,5 rpm
Swing torque	43 kNm

## STEERING SYSTEM

Steering control	Hydraulic steering system supplied from a separate gear pump and controlled through LS orbitrol & priority valves
Minimum turning radius	6.800 mm (to center of outer wheel)

## BRAKE SYSTEM

Type	Dual circuit hydraulic braking system supplied from a separate gear pump
Service brakes	Pedal actuated wet multi-disc brakes integrated into the axle hubs
Parking brake	Electrically actuated wet multi-disc "spring actuation hydraulic release" brake integrated into the transmission

## TRANSMISSION

Type	Fully automatic power shift transmission with permanent 4 wheel drive
Travel motors	One variable displacement axial piston motor
Maximum pressure	380 bar
Travel modes	Automatic + 3 travel modes
Max. travel speeds	
Hi / Lo / Creep	35,0 / 10,0 / 2,5 km/h
	A max. speed restriction of 20 km/h is available as an option
Maximum drawbar pull	10.900 kg
Axle oscillation	10° Lockable in any position from the operator cab

## SERVICE REFILL CAPACITIES

Fuel tank	310 l
Radiator	35 l
Engine oil	23,1 l
Swing drive	5,5 l
Hydraulic tank	167 l
Transmission	3,0 l
Front differential	9,5 l
Rear differential	12,4 l
Front axle hub	2,5 l
Rear axle hub	2,5 l
Swing pinion grease bath amount	10,5 l
AdBlue® tank	29,6 l

## ENVIRONMENT

Engine emissions	Fully complies with EU Stage IV exhaust emission regulations
Noise levels	
LwA external	101 dB(A) (2000/14/EC Stage II)
LpA operator ear	69 dB(A) (ISO 6396 dynamic test)
Vibration levels (EN 12096:1997)	
Hand/arm	≤ 2,5 m/s <sup>2</sup> (uncertainty K = 0,49 m/s <sup>2</sup> )
Body	≤ 0,5 m/s <sup>2</sup> (uncertainty K = 0,16 m/s <sup>2</sup> )
Contains fluorinated greenhouse gas HFC-134a (GWP 1430). Quantity of gas 0,9 kg, CO <sub>2</sub> equivalent 1,29 t	

**OPERATING WEIGHT (APPR.)**

Undercarriage attachment type	Mono boom	Two-piece boom
Without	17.740 kg	17.910 kg
Rear blade	18.595 kg	18.765 kg
Rear outrigger	18.810 kg	18.980 kg
2 outriggers + blade	19.670 kg	19.840 kg
4 outriggers	19.880 kg	20.050 kg

Operating weight, including specified work equipment, 2.600 mm arm, operator, lubricant, coolant, full fuel tank, bucket (530 kg) and the standard equipment.

**MAX. BUCKET CAPACITY AND WEIGHT**

Arm length	Mono boom		
	2,25 m	2,6 m	2,9 m
Material weight up to 1,2 t/m <sup>3</sup>	1,13 m <sup>3</sup> 675 kg	1,04 m <sup>3</sup> 645 kg	0,94 m <sup>3</sup> 615 kg
Material weight up to 1,5 t/m <sup>3</sup>	0,94 m <sup>3</sup> 615 kg	0,85 m <sup>3</sup> 585 kg	0,75 m <sup>3</sup> 525 kg
Material weight up to 1,8 t/m <sup>3</sup>	0,85 m <sup>3</sup> 585 kg	0,75 m <sup>3</sup> 525 kg	0,66 m <sup>3</sup> 495 kg
Arm length	Two-piece boom		
	2,25 m	2,6 m	2,9 m
Material weight up to 1,2 t/m <sup>3</sup>	1,13 m <sup>3</sup> 675 kg	1,04 m <sup>3</sup> 645 kg	0,94 m <sup>3</sup> 615 kg
Material weight up to 1,5 t/m <sup>3</sup>	0,94 m <sup>3</sup> 615 kg	0,85 m <sup>3</sup> 585 kg	0,75 m <sup>3</sup> 525 kg
Material weight up to 1,8 t/m <sup>3</sup>	0,85 m <sup>3</sup> 585 kg	0,75 m <sup>3</sup> 525 kg	0,66 m <sup>3</sup> 495 kg

Max. capacity and weight have been calculated according to ISO 10567:2007.

Please consult with your distributor for the correct selection of buckets and attachments to suit the application.

**BUCKET AND ARM FORCE**

Arm length	2,25 m	2,6 m	2,9 m
Bucket digging force	10.200 kg (115 kN)	10.200 kg (115 kN)	10.200 kg (115 kN)
Bucket digging force at PowerMax	12.500 kg (123 kN)	12.500 kg (123 kN)	12.500 kg (123 kN)
Arm crowd force	9.100 kg (89 kN)	8.200 kg (80 kN)	7.600 kg (74 kN)
Arm crowd force at PowerMax	9.700 kg (95 kN)	9.000 kg (88 kN)	8.100 kg (79 kN)

# Dimensions & Performance Figures

## MONO BOOM

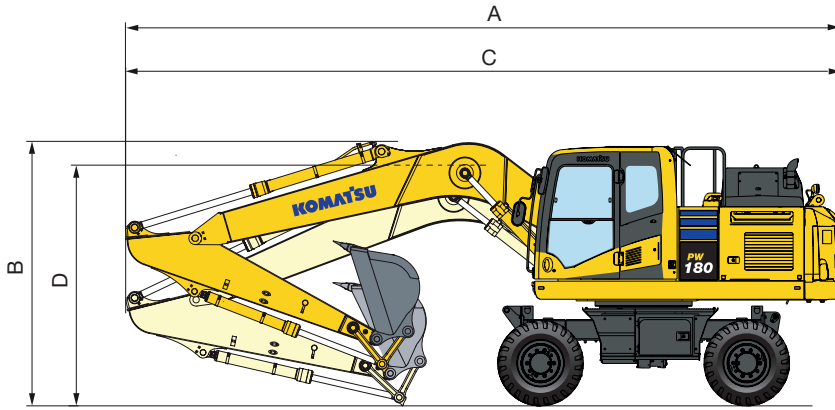

### Driving position

Arm length	A	B
2,25 m	8.930 mm	3.565 mm
2,6 m	8.930 mm	3.565 mm
2,9 m *	8.930 mm	3.565 mm

### Transport position

Arm length	C	D
2,25 m	8.970 mm	3.155 mm
2,6 m	8.975 mm	3.170 mm
2,9 m	8.985 mm	3.255 mm

\* Driving position without bucket

## TWO-PIECE BOOM

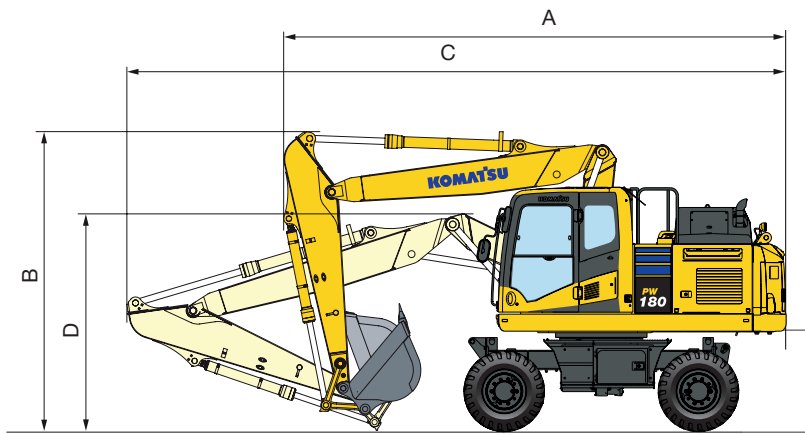

### Driving position

Arm length	A	B
2,25 m	6.740 mm	3.945 mm
2,6 m	6.745 mm	3.945 mm
2,9 m *	6.780 mm	3.945 mm

### Transport position

Arm length	C	D**
2,25 m	8.910 mm	3.085 mm
2,6 m	8.905 mm	3.145 mm
2,9 m	8.875 mm	3.240 mm

\* Driving position without bucket

\*\* Height to top of hose

PW180-11



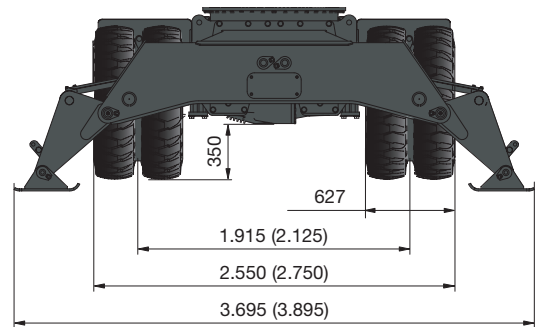
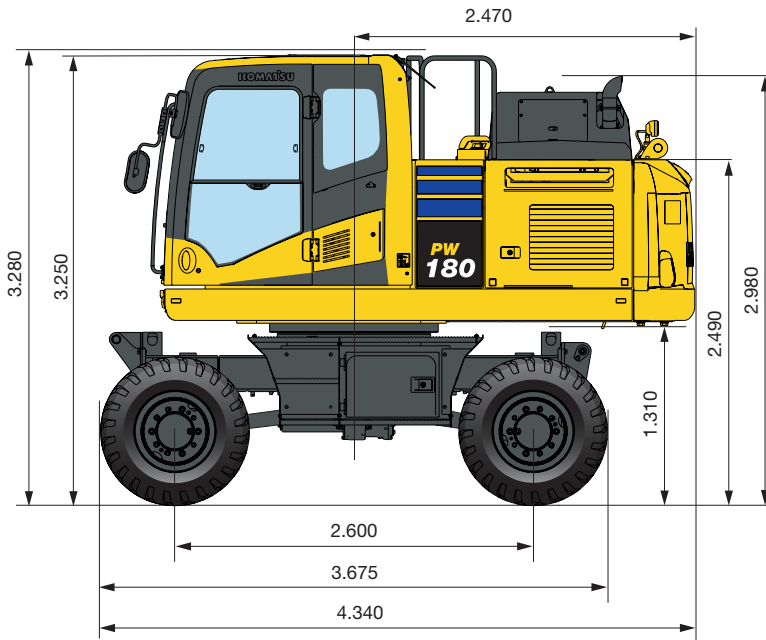

All dimensions with tyres Bandenmarkt Excavator 315/70 R22.5

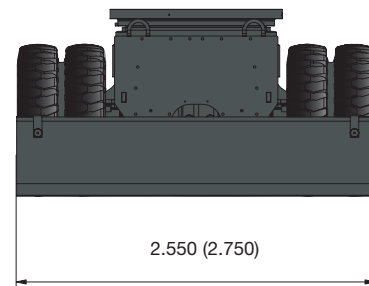

( ): Figures for 2,75 m undercarriage

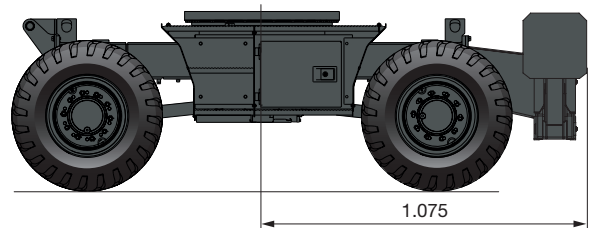
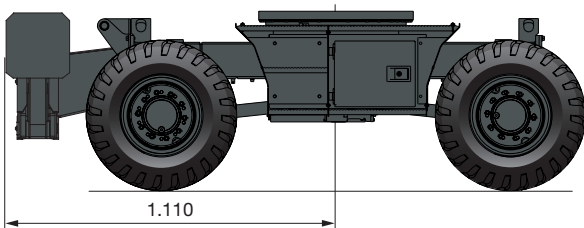
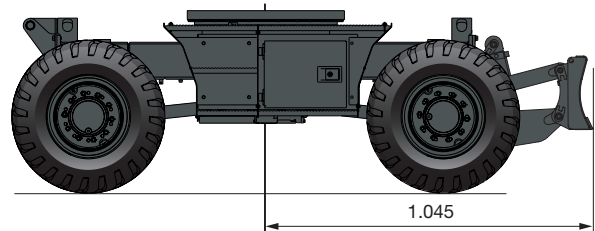
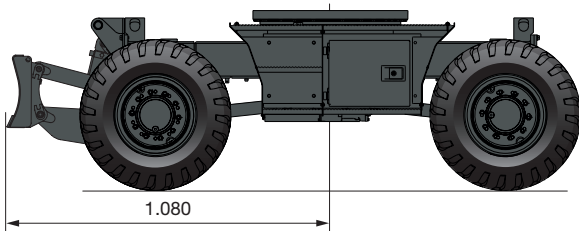

# Working Range

## MONO BOOM

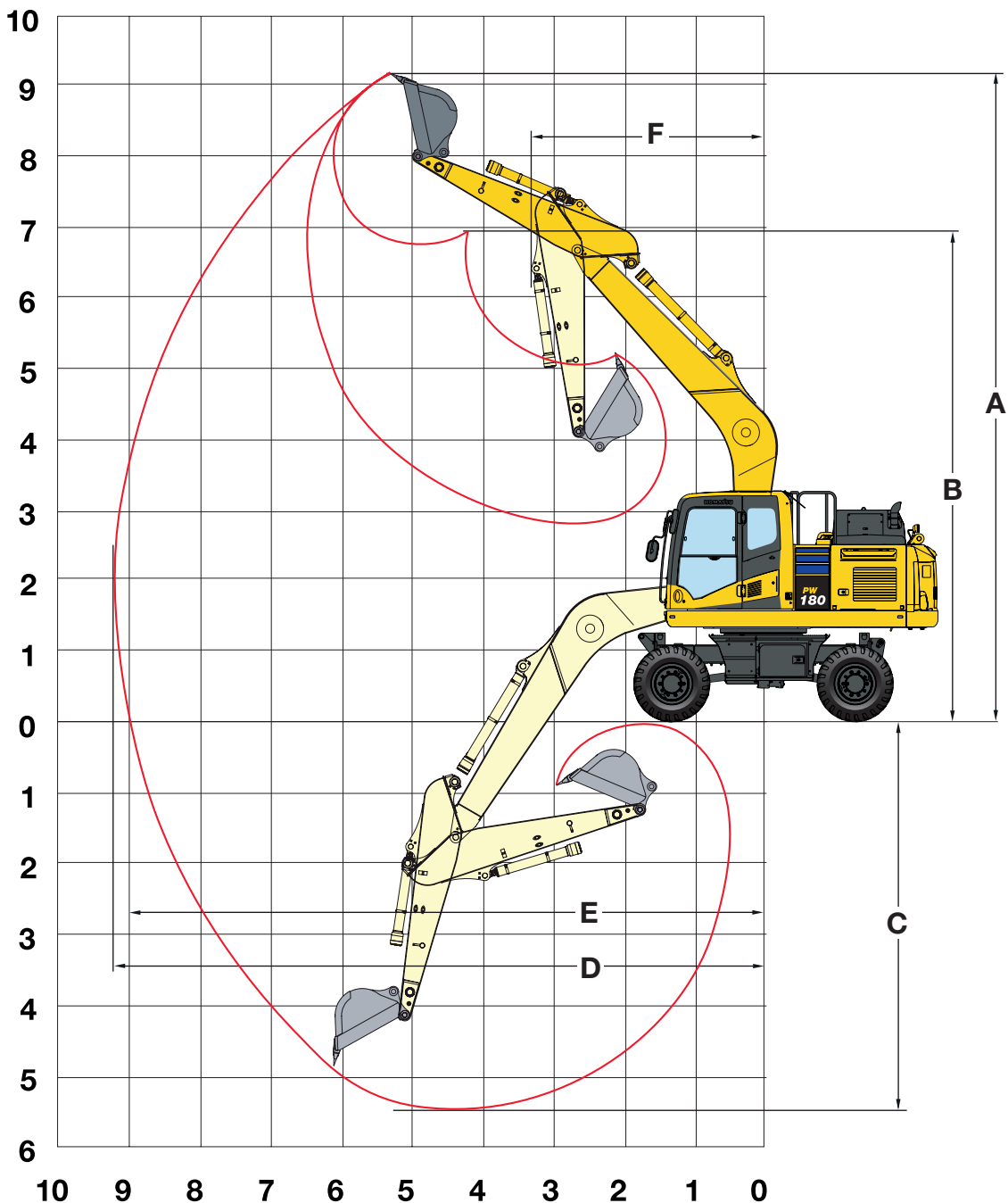

ARM LENGTH	2,25 m	2,6 m	2,9 m
A Max. digging height	9.458 mm	9.562 mm	9.756 mm
B Max. dumping height	6.915 mm	7.064 mm	7.236 mm
C Max. digging depth	5.321 mm	5.676 mm	5.966 mm
D Max. digging reach	9.061 mm	9.345 mm	9.929 mm
E Max. digging reach at ground level	8.907 mm	9.227 mm	9.509 mm
F Min. swing radius	3.543 mm	3.829 mm	4.057 mm

PW180-11

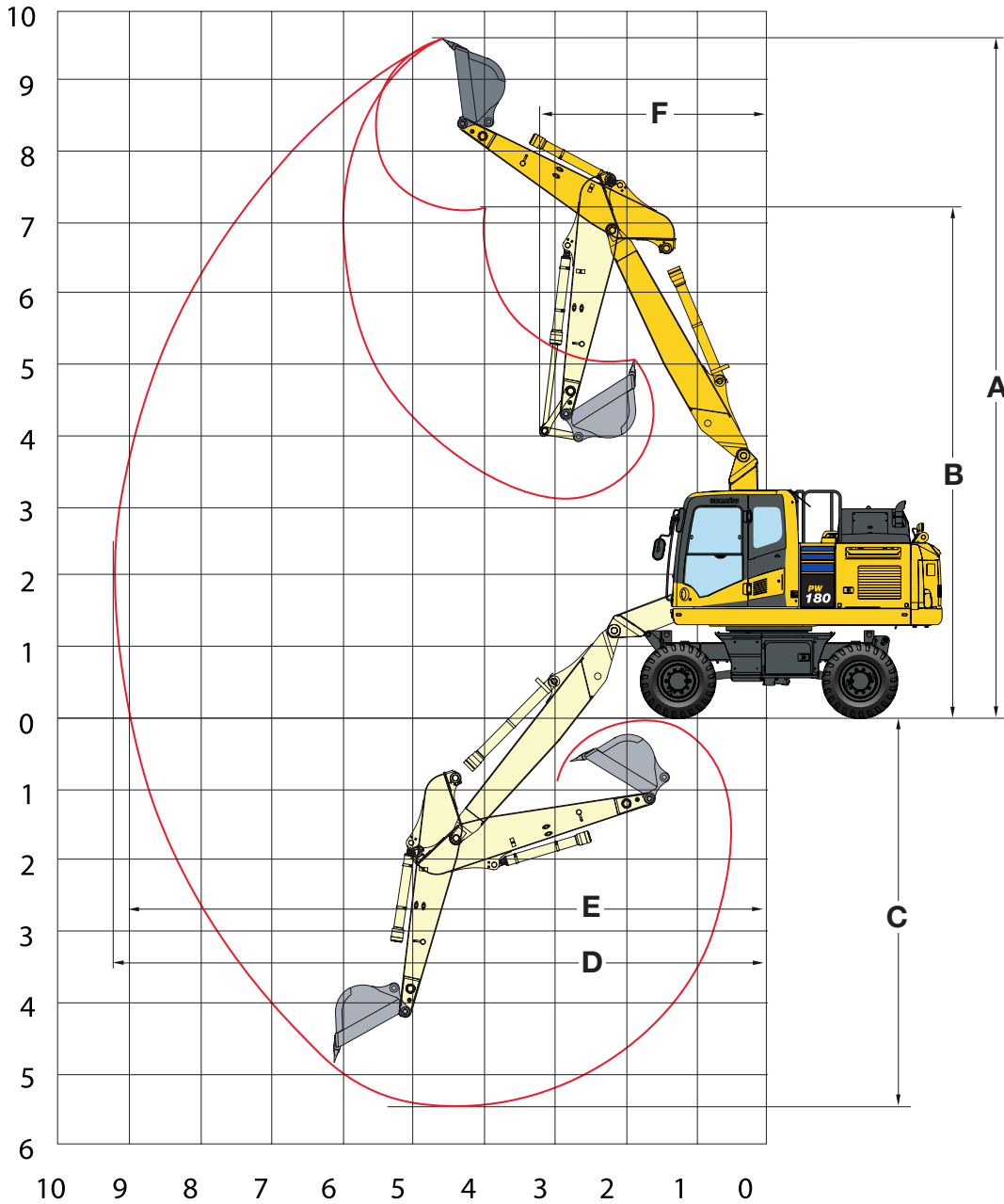

TWO-PIECE BOOM





ARM LENGTH	2,25 m	2,6 m	2,9 m
A Max. digging height	9.942 mm	10.129 mm	10.350 mm
B Max. dumping height	7.283 mm	7.489 mm	7.709 mm
C Max. digging depth	5.400 mm	5.742 mm	6.044 mm
D Max. digging reach	9.080 mm	9.401 mm	9.683 mm
E Max. digging reach at ground level	8.907 mm	9.227 mm	9.509 mm
F Min. swing radius	3.065 mm	3.311 mm	3.511 mm

# Lifting Capacity

## Mono boom / undercarriage width 2,55 m

Arm length	A B	⊗		7,5 m		6,0 m		4,5 m		3,0 m		1,5 m		
		⊗	⊗	⊗	⊗	⊗	⊗	⊗	⊗	⊗	⊗	⊗	⊗	
 <p>Without stabilizer</p>	2,25 m	7,5 m kg	*3.350	*3.350					*5.150	4.800				
		6,0 m kg	*3.000	2.450			4.150	3.000		*5.600	4.800			
		4,5 m kg	2.850	2.000	2.850	2.000	4.050	2.900	6.350	4.500	*8.150	*8.150		
		3,0 m kg	2.550	1.800	2.750	1.950	3.900	2.750	5.950	4.150				
		1,5 m kg	2.400	1.700	2.700	1.900	3.700	2.550	5.550	3.800				
		0,0 m kg	2.450	1.750	2.600	1.800	3.550	2.450	5.300	3.600				
		- 1,5 m kg	2.750	1.900			3.500	2.400	5.250	3.550	*9.100	6.400		
		- 3,0 m kg	3.350	2.350			3.550	2.450	5.300	3.600	*8.500	6.550		
	- 4,5 m kg													
	2,6 m	7,5 m kg	*2.750	*2.750										
		6,0 m kg	*2.550	2.250			4.200	3.050						
		4,5 m kg	*2.450	1.850	2.850	2.000	4.050	2.950	*6.050	4.600				
		3,0 m kg	2.400	1.650	2.750	1.950	3.900	2.750	6.000	4.200				
		1,5 m kg	2.250	1.600	2.650	1.850	3.650	2.550	5.550	3.800				
		0,0 m kg	2.250	1.600	2.550	1.800	3.500	2.400	5.250	3.550	*5.600	*5.600		
		- 1,5 m kg	2.400	1.750	2.550	1.750	3.450	2.400	5.200	3.450	*8.950	6.300		
		- 3,0 m kg	3.000	2.100			3.450	2.400	5.250	3.500	*9.450	6.400		
	- 4,5 m kg													
	2,9 m	7,5 m kg	*2.350	*2.350			*3.000	*3.000						
		6,0 m kg	*2.150	2.050			*4.100	3.000						
		4,5 m kg	*2.100	1.700	2.800	1.950	4.050	2.900	*5.050	4.600				
		3,0 m kg	*2.150	1.500	2.700	1.900	3.850	2.700	6.000	4.200	11.750	7.700		
		1,5 m kg	2.100	1.450	2.600	1.800	3.650	2.550	5.550	3.800				
		0,0 m kg	2.150	1.500	2.500	1.700	3.450	2.400	5.250	3.550	*5.750	*5.750		
		- 1,5 m kg	2.350	1.600	2.400	1.650	3.400	2.300	5.150	3.450	*8.500	6.200	*5.100	*5.100
		- 3,0 m kg	2.700	1.900			3.400	2.300	5.150	3.450	10.100	6.300		
	- 4,5 m kg	*4.150	3.000						*4.800	3.600				
 <p>Front or rear blade</p>	2,25 m	7,5 m kg	*3.350	*3.350					*5.150	*5.200				
		6,0 m kg	*3.000	2.850			*5.000	3.450	*5.600	5.450				
		4,5 m kg	*2.900	2.350	*2.900	2.350	*6.050	3.350	*7.250	5.200	*8.150	*8.150		
		3,0 m kg	*2.950	2.100	*5.000	2.250	*6.550	3.150	*8.600	4.800				
		1,5 m kg	*3.100	2.000	5.450	2.200	*6.950	3.000	*9.550	4.400				
		0,0 m kg	*3.450	2.050	*5.300	2.150	*7.000	2.850	*9.450	4.200				
		- 1,5 m kg	*4.150	2.250			*6.400	2.850	*8.600	4.200	*9.100	7.650		
		- 3,0 m kg	*4.150	2.700			*4.700	2.850	*6.700	4.200	*8.500	7.800		
	- 4,5 m kg													
	2,6 m	7,5 m kg	*2.750	*2.750										
		6,0 m kg	*2.550	*2.550			*4.500	3.450						
		4,5 m kg	*2.450	2.150	*3.600	2.350	*5.550	3.350	*6.050	5.250				
		3,0 m kg	*2.550	1.950	*4.950	2.250	*6.350	3.150	*8.250	4.800				
		1,5 m kg	*2.700	1.850	5.400	2.150	*6.800	3.000	*9.300	4.400				
		0,0 m kg	*3.050	1.900	*5.350	2.100	*6.950	2.850	*9.550	4.200	*5.600	*5.600		
		- 1,5 m kg	*3.600	2.050	*4.150	2.100	*6.500	2.800	*8.750	4.100	*8.950	7.500		
		- 3,0 m kg	*4.250	2.450			*5.200	2.800	*7.150	4.150	*9.450	7.650		
	- 4,5 m kg													
	2,9 m	7,5 m kg	*2.350	*2.350			*3.000	*3.000						
		6,0 m kg	*2.150	*2.200			*4.100	3.450						
		4,5 m kg	*2.100	2.000	*3.700	2.300	*4.900	3.300	*5.050	*5.050				
		3,0 m kg	*2.150	1.800	*4.700	2.250	*6.100	3.150	*7.800	4.850	*12.050	9.000		
		1,5 m kg	*2.300	1.700	*5.350	2.100	*6.650	2.950	*9.100	4.450				
		0,0 m kg	*2.600	1.750	5.250	2.050	*6.850	2.800	*9.450	4.150	*5.750	*5.750		
		- 1,5 m kg	*3.050	1.900	*4.850	2.000	*6.550	2.700	*8.950	4.050	*8.500	7.400	*5.100	*5.100
		- 3,0 m kg	*4.050	2.250			*5.500	2.700	*7.550	4.050	*10.250	7.550		
	- 4,5 m kg	*4.150	3.550						*4.800	4.200				
 <p>Rear outrigger</p>	2,25 m	7,5 m kg	*3.350	*3.350					*5.150	*5.150				
		6,0 m kg	*3.000	*3.000			*5.000	4.150	*5.600	*5.600				
		4,5 m kg	*2.900	2.850	*2.900	2.850	*6.050	4.050	*7.250	6.300	*8.150	*8.150		
		3,0 m kg	*2.950	2.550	*5.000	2.800	*6.550	3.900	*8.600	5.850				
		1,5 m kg	*3.100	2.450	5.100	2.700	6.900	3.700	*9.550	5.450				
		0,0 m kg	*3.450	2.500	5.050	2.650	*7.000	3.550	*9.450	5.250				
		- 1,5 m kg	*4.150	2.750			*6.400	3.500	*8.600	5.200	*9.100	*9.100		
		- 3,0 m kg	*4.150	3.350			*4.700	3.550	*6.700	5.250	*8.500	*8.500		
	- 4,5 m kg													
	2,6 m	7,5 m kg	*2.750	*2.750										
		6,0 m kg	*2.550	*2.550			*4.500	4.200						
		4,5 m kg	*2.450	*2.500	*3.600	2.850	*5.550	4.050	*6.050	*6.000				
		3,0 m kg	*2.550	2.400	*4.950	2.750	*6.350	3.900	*8.250	5.900				
		1,5 m kg	*2.700	2.300	5.100	2.700	*6.800	3.650	*9.300	5.500				
		0,0 m kg	*3.050	2.350	4.950	2.600	*6.950	3.500	*9.550	5.250	*5.600	*5.600		
		- 1,5 m kg	*3.600	2.550	*4.150	2.550	*6.500	3.450	*8.750	5.100	*8.950	*8.950		
		- 3,0 m kg	*4.250	3.000			*5.200	3.450	*7.150	5.150	*9.450	*9.450		
	- 4,5 m kg													
	2,9 m	7,5 m kg	*2.350	*2.350			*3.000	*3.000						
		6,0 m kg	*2.150	*2.150			*4.100	*4.100						
		4,5 m kg	*2.100	*2.100	*3.700	2.800	*4.900	4.050	*5.050	*5.050				
		3,0 m kg	*2.150	*2.150	*4.700	2.700	*6.100	3.850	*7.800	5.950	*12.050	11.300		
		1,5 m kg	*2.300	2.150	5.000	2.600	*6.650	3.600	*9.100	5.500				
		0,0 m kg	*2.600	2.150	4.950	2.550	6.850	3.450	*9.450	5.200	*5.750	*5.750		
		- 1,5 m kg	*3.050	2.350	4.850	2.500	*6.550	3.400	*8.950	5.100	*8.500	*8.500	*5.100	*5.100
		- 3,0 m kg	*4.050	2.750			*5.500	3.400	*7.550	5.100	*10.250	9.750		
	- 4,5 m kg	*4.150	*4.150						*4.800	*4.800				

PW180-11

Arm length	A	B	⊗		7,5 m		6,0 m		4,5 m		3,0 m		1,5 m	
			👤	👤	👤	👤	👤	👤	👤	👤	👤	👤	👤	👤
 <p>Outrigger + blade</p>	2,25 m	7,5 m	kg	*3.350	*3.350					*5.150	*5.150			
		6,0 m	kg	*3.000	*3.000			*5.000	*5.000	*5.600	*5.600			
		4,5 m	kg	*2.900	*2.900	*2.900	*2.900	*6.050	5.050	*7.250	*7.250	*8.150	*8.150	
		3,0 m	kg	*2.950	*2.950	*5.000	3.450	*6.550	4.850	*8.600	7.500			
		1,5 m	kg	*3.100	3.100	*5.500	3.400	*6.950	4.650	*9.550	7.050			
		0,0 m	kg	*3.450	3.150	*5.300	3.300	*7.000	4.500	*9.450	6.850			
		- 1,5 m	kg	*4.150	3.450			*6.400	4.500	*8.600	6.800	*9.100	*9.100	
		- 3,0 m	kg	*4.150	*4.150			*4.700	4.500	*6.700	*6.700	*8.500	*8.500	
	- 4,5 m	kg												
	2,6 m	7,5 m	kg	*2.750	*2.750									
		6,0 m	kg	*2.550	*2.550			*4.500	*4.500					
		4,5 m	kg	*2.450	*2.450	*3.600	3.550	*5.550	5.050	*6.050	*6.050			
		3,0 m	kg	*2.550	*2.550	*4.950	3.450	*6.350	4.850	*8.250	7.550			
		1,5 m	kg	*2.700	*2.700	*5.450	3.350	*6.800	4.650	*9.300	7.100			
		0,0 m	kg	*3.050	3.000	*5.350	3.300	*6.950	4.500	*9.550	6.800	*5.600	*5.600	
		- 1,5 m	kg	*3.600	3.250	*4.150	3.300	*6.500	4.400	*8.750	6.750	*8.950	*8.950	
		- 3,0 m	kg	*4.250	3.900			*5.200	4.450	*7.150	6.750	*9.450	*9.450	
	- 4,5 m	kg												
	2,9 m	7,5 m	kg	*2.350	*2.350			*3.000	*3.000					
		6,0 m	kg	*2.150	*2.150			*4.100	*4.100					
		4,5 m	kg	*2.100	*2.100	*3.700	3.500	*4.900	*4.900	*5.050	*5.050			
		3,0 m	kg	*2.150	*2.150	*4.700	3.450	*6.100	4.850	*7.800	7.650	*12.050	*12.050	
		1,5 m	kg	*2.300	*2.300	*5.350	3.300	*6.650	4.650	*9.100	7.100			
		0,0 m	kg	*2.600	*2.600	*5.350	3.250	*6.850	4.450	*9.450	6.800	*5.750	*5.750	
- 1,5 m		kg	*3.050	3.000	*4.850	3.200	*6.550	4.350	*8.950	6.650	*8.500	*8.500		
- 3,0 m		kg	*4.050	3.550			*5.500	4.350	*7.550	6.700	*10.250	*10.250		
- 4,5 m	kg	*4.150	*4.150					*4.800	*4.800					
 <p>Outrigger front + rear</p>	2,25 m	7,5 m	kg	*3.350	*3.350					*5.150	*5.150			
		6,0 m	kg	*3.000	*3.000			*5.000	*5.000	*5.600	*5.600			
		4,5 m	kg	*2.900	*2.900	*2.900	*2.900	*6.050	*6.050	*7.250	*7.250	*8.150	*8.150	
		3,0 m	kg	*2.950	*2.950	*5.000	3.950	*6.550	6.000	*8.600	*8.600			
		1,5 m	kg	*3.100	*3.100	*5.500	4.150	*6.950	5.750	*9.550	9.000			
		0,0 m	kg	*3.450	*3.450	*5.300	3.800	*7.000	5.600	*9.450	8.750			
		- 1,5 m	kg	*4.150	*4.150			*6.400	5.550	*8.600	*8.600	*9.100	*9.100	
		- 3,0 m	kg	*4.150	*4.150			*4.700	*4.700	*6.700	*6.700	*8.500	*8.500	
	- 4,5 m	kg												
	2,6 m	7,5 m	kg	*2.750	*2.750									
		6,0 m	kg	*2.550	*2.550			*4.500	*4.500					
		4,5 m	kg	*2.450	*2.450	*3.600	*3.600	*5.550	*5.550	*6.050	*6.050			
		3,0 m	kg	*2.550	*2.550	*4.950	4.200	*6.350	6.000	*8.250	*8.250			
		1,5 m	kg	*2.700	*2.700	*5.450	3.850	*6.800	5.750	*9.300	9.000			
		0,0 m	kg	*3.050	*3.050	*5.350	4.050	*6.950	5.550	*9.550	8.700	*5.600	*5.600	
		- 1,5 m	kg	*3.600	*3.600	*4.150	4.050	*6.500	5.500	*8.750	8.600	*8.950	*8.950	
		- 3,0 m	kg	*4.250	*4.250			*5.200	*5.200	*7.150	*7.150	*9.450	*9.450	
	- 4,5 m	kg												
	2,9 m	7,5 m	kg	*2.350	*2.350			*3.000	*3.000					
		6,0 m	kg	*2.150	*2.150			*4.100	*4.100					
		4,5 m	kg	*2.100	*2.100	*3.700	*3.700	*4.900	*4.900	*5.050	*5.050			
		3,0 m	kg	*2.150	*2.150	*4.700	4.200	*6.100	5.950	*7.800	*7.800	*12.050	*12.050	
		1,5 m	kg	*2.300	*2.300	*5.350	4.050	*6.650	5.700	*9.100	9.050			
		0,0 m	kg	*2.600	*2.600	*5.350	4.000	*6.850	5.550	*9.450	8.700	*5.750	*5.750	
- 1,5 m		kg	*3.050	*3.050	*4.850	3.950	*6.550	5.450	*8.950	8.550	*8.500	*8.500		
- 3,0 m		kg	*4.050	*4.050			*5.500	5.450	*7.550	*7.550	*10.250	*10.250		
- 4,5 m	kg	*4.150	*4.150					*4.800	*4.800					

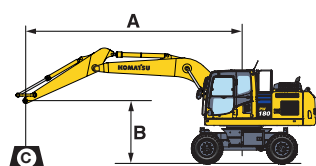

- A – Reach from swing center
- B – Bucket hook height
- C – Lifting capacities, including bucket linkage (120 kg) and bucket cylinder (109 kg)

When removing linkage or cylinder, lifting capacities can be increased by their respective weights.

\* Load is limited by hydraulic capacity rather than tipping. Ratings are based on SAE Standard No. J1097. Rated loads do not exceed 87% of hydraulic lift capacity or 75% of tipping load.



- 👤 – Rating over front
- 👤 – Rating over side
- ⊗ – Rating at maximum reach

# Lifting Capacity

## Two-piece boom / undercarriage width 2,55 m

Arm length	A	⊗		7,5 m		6,0 m		4,5 m		3,0 m		1,5 m		
		B	⊗	⊗	⊗	⊗	⊗	⊗	⊗	⊗	⊗	⊗	⊗	
			⊗	⊗	⊗	⊗	⊗	⊗	⊗	⊗	⊗	⊗	⊗	⊗
 <p>Without stabilizer</p>	2,25 m	7,5 m kg	*3.650	3.400					*5.450	4.800				
		6,0 m kg	*3.150	2.400			4.150	3.000		*5.400	4.800			
		4,5 m kg	2.800	2.000	2.850	2.050	4.050	2.950	6.350	4.550	*6.350	*6.350		
		3,0 m kg	2.550	1.800	2.800	1.950	3.900	2.800	6.000	4.200				
		1,5 m kg	2.400	1.750	2.700	1.950	3.650	2.600	5.600	3.800				
		0,0 m kg	2.550	1.800	2.700	1.850	3.600	2.550	5.400	3.650				
	- 1,5 m kg	2.750	1.950			3.600	2.450	5.400	3.600	*8.250	6.600			
	- 3,0 m kg													
	- 4,5 m kg													
	2,6 m	7,5 m kg	*3.000	*3.000										
		6,0 m kg	*2.700	2.200			4.200	3.000						
		4,5 m kg	*2.550	1.850	2.850	2.050	4.050	2.950	*5.400	4.600				
		3,0 m kg	2.400	1.650	2.750	1.950	3.900	2.800	6.000	4.200				
		1,5 m kg	2.300	1.600	2.700	1.900	3.750	2.550	5.600	3.850				
		0,0 m kg	2.350	1.650	2.650	1.800	3.600	2.450	5.400	3.600				
	- 1,5 m kg	2.550	1.800	2.600	1.800	3.350	2.400	5.300	3.550	*8.150	6.450			
	- 3,0 m kg	3.250	2.250			3.550	2.450	5.350	3.600					
	- 4,5 m kg													
	2,9 m	7,5 m kg	*2.550	*2.550			*3.450	3.000						
		6,0 m kg	*2.300	2.000			4.150	3.000						
		4,5 m kg	*2.200	1.650	2.800	1.950	4.050	2.900	*4.550	*4.550				
		3,0 m kg	2.200	1.500	2.700	1.950	3.900	2.750	6.000	4.200				
		1,5 m kg	2.100	1.450	2.650	1.800	3.700	2.550	5.600	3.850				
		0,0 m kg	2.150	1.500	2.550	1.750	3.550	2.400	5.350	3.600	*4.900	*4.900		
- 1,5 m kg	2.350	1.650	2.500	1.750	3.450	2.350	5.250	3.500	*7.700	6.350				
- 3,0 m kg	2.850	1.950			3.450	2.350	5.250	3.550						
- 4,5 m kg														
 <p>Front or rear blade</p>	2,25 m	7,5 m kg	*3.650	*3.650					*5.450	5.450				
		6,0 m kg	*3.150	2.800			*5.200	3.450	*5.400	*5.350				
		4,5 m kg	*3.000	2.300	*3.350	2.350	*5.600	3.350	*6.500	5.200	*6.350	*6.350		
		3,0 m kg	*3.000	2.100	*4.750	2.300	*5.950	3.200	*8.250	4.800				
		1,5 m kg	*3.050	2.000	*4.950	2.250	*6.400	3.050	*9.550	4.500				
		0,0 m kg	*3.350	2.100	*5.200	2.200	*7.000	2.950	*9.550	4.300				
	- 1,5 m kg	*3.850	2.250			*6.400	2.900	*8.700	4.250	*8.250	7.850			
	- 3,0 m kg													
	- 4,5 m kg													
	2,6 m	7,5 m kg	*3.000	*3.000										
		6,0 m kg	*2.700	2.550			*4.650	3.450						
		4,5 m kg	*2.550	2.150	*3.950	2.350	*5.400	3.350	*5.400	5.250				
		3,0 m kg	*2.550	1.950	*4.600	2.250	*5.700	3.200	*7.800	4.850				
		1,5 m kg	*2.650	1.900	*4.800	2.200	*6.200	3.000	*9.300	4.500				
		0,0 m kg	*2.900	1.950	*5.050	2.150	*6.750	2.900	*9.550	4.250				
	- 1,5 m kg	*3.350	2.100	*4.600	2.100	*6.600	2.850	*8.950	4.200	*8.150	7.700			
	- 3,0 m kg	*4.700	2.700			*5.250	2.850	*7.300	4.200					
	- 4,5 m kg													
	2,9 m	7,5 m kg	*2.550	*2.550			*3.450	3.450						
		6,0 m kg	*2.300	*2.300			*4.150	3.450						
		4,5 m kg	*2.200	1.950	*3.900	2.300	*4.700	3.300	*4.550	*4.550				
		3,0 m kg	*2.200	1.800	*4.400	2.250	*5.550	3.150	*7.550	4.850				
		1,5 m kg	*2.300	1.750	*4.650	2.150	*6.050	3.000	*8.850	4.500				
		0,0 m kg	*2.450	1.750	*4.900	2.100	*6.600	2.850	*9.550	4.200	*4.900	*4.900		
- 1,5 m kg	*2.850	1.900	*4.900	2.050	*6.650	2.800	*9.050	4.150	*7.700	7.650				
- 3,0 m kg	*4.150	2.300			*5.550	2.800	*7.650	4.150						
- 4,5 m kg														
 <p>Rear outrigger</p>	2,25 m	7,5 m kg	*3.650	*3.600					*5.450	*5.450				
		6,0 m kg	*3.150	*3.150			*5.200	4.150	*5.400	*5.350				
		4,5 m kg	*3.000	2.850	*3.350	2.850	*5.600	4.050	*6.500	6.300	*6.350	*6.350		
		3,0 m kg	*3.000	2.550	*4.750	2.800	*5.950	3.900	*8.250	5.900				
		1,5 m kg	*3.050	2.500	*4.950	2.700	*6.400	3.750	*9.550	5.550				
		0,0 m kg	*3.350	2.550	5.100	2.700	*7.000	3.600	*9.550	5.350				
	- 1,5 m kg	*3.850	2.800			*6.400	3.600	*8.700	5.300	*8.250	*8.250			
	- 3,0 m kg													
	- 4,5 m kg													
	2,6 m	7,5 m kg	*3.000	*3.000										
		6,0 m kg	*2.700	*2.650			*4.650	4.150						
		4,5 m kg	*2.550	*2.550	*3.950	2.850	*5.400	4.050	*5.400	*5.400				
		3,0 m kg	*2.550	2.400	*4.600	2.800	*5.700	3.900	*7.800	5.950				
		1,5 m kg	*2.650	2.300	*4.800	2.700	*6.200	3.700	*9.300	5.550				
		0,0 m kg	*2.900	2.400	*5.050	2.650	*6.750	3.600	*9.550	5.300				
	- 1,5 m kg	*3.350	2.550	*4.600	2.650	*6.600	3.500	*8.950	5.250	*8.150	*8.150			
	- 3,0 m kg	*4.700	3.300			*5.250	3.550	*7.300	5.300					
	- 4,5 m kg													
	2,9 m	7,5 m kg	*2.550	*2.550			*3.450	*3.450						
		6,0 m kg	*2.300	*2.300			*4.150	4.150						
		4,5 m kg	*2.200	*2.200	*3.900	2.850	*4.700	4.050	*4.550	*4.550				
		3,0 m kg	*2.200	*2.200	*4.400	2.750	*5.550	3.850	*7.550	5.950				
		1,5 m kg	*2.300	2.150	*4.650	2.650	*6.050	3.650	*8.850	5.550				
		0,0 m kg	*2.450	2.200	*4.900	2.550	*6.600	3.550	*9.550	5.250	*4.900	*4.900		
- 1,5 m kg	*2.850	2.400	*4.900	2.550	*6.650	3.450	*9.050	5.200	*7.700	*7.700				
- 3,0 m kg	*4.150	2.850			*5.550	3.450	*7.650	5.250						
- 4,5 m kg														

PW180-11

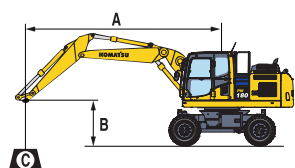

Arm length	A B	⊗		7,5 m		6,0 m		4,5 m		3,0 m		1,5 m		
		⊗	⊗	⊗	⊗	⊗	⊗	⊗	⊗	⊗	⊗	⊗	⊗	
 <p>Outrigger + blade</p>	2,25 m	7,5 m	kg	*3.650	*3.650			*5.450	*5.450					
		6,0 m	kg	*3.150	*3.150			*5.200	5.150	*5.400	*5.400			
		4,5 m	kg	*3.000	*3.000	*3.350	*3.350	*5.600	5.050	*6.500	*6.500	*6.350	*6.350	
		3,0 m	kg	*3.000	*3.000	*4.750	3.500	*5.950	4.900	*8.250	7.550			
		1,5 m	kg	*3.050	*3.050	*4.950	3.450	*6.400	4.700	*9.550	7.150			
		0,0 m	kg	*3.350	3.200	*5.200	3.400	*7.000	4.600	*9.550	6.950			
		- 1,5 m	kg	*3.850	3.550			*6.400	4.550	*8.700	6.900	*8.250	*8.250	
		- 3,0 m	kg											
	- 4,5 m	kg												
	2,6 m	7,5 m	kg	*3.000	*3.000									
		6,0 m	kg	*2.700	*2.700			*4.650	*4.650					
		4,5 m	kg	*2.550	*2.550	*3.950	3.600	*5.400	5.100	*5.400	*5.400			
		3,0 m	kg	*2.550	*2.550	*4.600	3.500	*5.700	4.900	*7.800	7.650			
		1,5 m	kg	*2.650	*2.650	*4.800	3.400	*6.200	4.700	*9.300	7.200			
		0,0 m	kg	*2.900	*2.900	*5.050	3.350	*6.750	4.550	*9.550	6.900			
		- 1,5 m	kg	*3.350	3.300	*4.600	3.300	*6.600	4.500	*8.950	6.850	*8.150	*8.150	
		- 3,0 m	kg	*4.700	4.200			*5.250	4.550	*7.300	6.900			
	- 4,5 m	kg												
	2,9 m	7,5 m	kg	*2.550	*2.550			*3.450	*3.450					
		6,0 m	kg	*2.300	*2.300			*4.150	*4.150					
		4,5 m	kg	*2.200	*2.200	*3.900	3.550	*4.700	*4.700	*4.550	*4.550			
		3,0 m	kg	*2.200	*2.200	*4.400	3.450	*5.550	4.850	*7.550	*7.550			
		1,5 m	kg	*2.300	*2.300	*4.650	3.350	*6.050	4.650	*8.850	7.200			
		0,0 m	kg	*2.450	*2.450	*4.900	3.300	*6.600	4.500	*9.550	6.900	*4.900	*4.900	
- 1,5 m		kg	*2.850	*2.850	*4.900	3.250	*6.650	4.450	*9.050	6.750	*7.700	*7.700		
- 3,0 m		kg	*4.150	3.650			*5.550	4.450	*7.650	6.800				
- 4,5 m	kg													
 <p>Outrigger front + rear</p>	2,25 m	7,5 m	kg	*3.650	*3.650			*5.450	*5.450					
		6,0 m	kg	*3.150	*3.150			*5.200	*5.200	*5.400	*5.400			
		4,5 m	kg	*3.000	*3.000	*3.350	*3.350	*5.600	*5.600	*6.500	*6.500	*6.350	*6.350	
		3,0 m	kg	*3.000	*3.000	*4.750	4.300	*5.950	*5.950	*8.250	*8.250			
		1,5 m	kg	*3.050	*3.050	*4.950	4.200	*6.400	5.850	*9.550	9.050			
		0,0 m	kg	*3.350	*3.350	*5.200	4.150	*7.000	5.700	*9.550	8.900			
		- 1,5 m	kg	*3.850	*3.850			*6.400	5.650	*8.700	*8.700	*8.250	*8.250	
		- 3,0 m	kg											
	- 4,5 m	kg												
	2,6 m	7,5 m	kg	*3.000	*3.000									
		6,0 m	kg	*2.700	*2.700			*4.650	*4.650					
		4,5 m	kg	*2.550	*2.550	*3.950	*3.950	*5.400	*5.400	*5.400	*5.400			
		3,0 m	kg	*2.550	*2.550	*4.600	4.250	*5.700	*5.700	*7.800	*7.800			
		1,5 m	kg	*2.650	*2.650	*4.800	4.200	*6.200	5.800	*9.300	9.150			
		0,0 m	kg	*2.900	*2.900	*5.050	3.850	*6.750	5.650	*9.550	8.850			
		- 1,5 m	kg	*3.350	*3.350	*4.600	4.100	*6.600	5.600	*8.950	8.750	*8.150	*8.150	
		- 3,0 m	kg	*4.700	*4.700			*5.250	*5.250	*7.300	*7.300			
	- 4,5 m	kg												
	2,9 m	7,5 m	kg	*2.550	*2.550			*3.450	*3.450					
		6,0 m	kg	*2.300	*2.300			*4.150	*4.150					
		4,5 m	kg	*2.200	*2.200	*3.900	*3.900	*4.700	*4.700	*4.550	*4.550			
		3,0 m	kg	*2.200	*2.200	*4.400	4.200	*5.550	*5.550	*7.550	*7.550			
		1,5 m	kg	*2.300	*2.300	*4.650	4.100	*6.050	5.750	*8.850	*8.850			
		0,0 m	kg	*2.450	*2.450	*4.900	4.050	*6.600	5.600	*9.550	8.850	*4.900	*4.900	
- 1,5 m		kg	*2.850	*2.850	*4.900	3.750	*6.650	5.550	*9.050	8.700	*7.700	*7.700		
- 3,0 m		kg	*4.150	*4.150			*5.550	*5.550	*7.650	*7.650				
- 4,5 m	kg													



- A – Reach from swing center
- B – Bucket hook height
- C – Lifting capacities, including bucket linkage (120 kg) and bucket cylinder (109 kg)



When removing linkage or cylinder, lifting capacities can be increased by their respective weights.

\* Load is limited by hydraulic capacity rather than tipping. Ratings are based on SAE Standard No. J1097. Rated loads do not exceed 87% of hydraulic lift capacity or 75% of tipping load.

-  – Rating over front
-  – Rating over side
-  – Rating at maximum reach





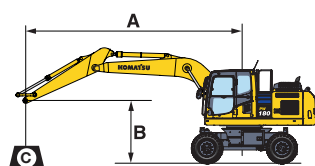

Arm length	A	⊗		7,5 m		6,0 m		4,5 m		3,0 m		1,5 m		
		⊗	⊗	⊗	⊗	⊗	⊗	⊗	⊗	⊗	⊗	⊗	⊗	
 <p>Outrigger + blade</p>	2,25 m	7,5 m kg	*3.350	*3.350					*5.150	*5.150				
		6,0 m kg	*3.000	*3.000			*5.000	*5.000	*5.600	*5.600				
		4,5 m kg	*2.900	*2.900	*2.900	*2.900	*6.050	5.600	*7.250	*7.250	*8.150	*8.150		
		3,0 m kg	*2.950	*2.950	*5.000	3.900	*6.550	5.400	*8.600	8.450				
		1,5 m kg	*3.100	*3.100	*5.500	3.800	*6.950	5.250	*9.550	8.100				
		0,0 m kg	*3.450	*3.450	5.250	3.750	*7.000	5.100	*9.450	7.850				
		- 1,5 m kg	*4.150	3.900			*6.400	5.050	*8.600	7.800	*9.100	*9.100		
		- 3,0 m kg	*4.150	*4.150			*4.700	*4.700	*6.700	*6.700	*8.500	*8.500		
		- 4,5 m kg												
	2,6 m	7,5 m kg	*2.750	*2.750										
		6,0 m kg	*2.550	*2.550			*4.500	*4.500						
		4,5 m kg	*2.450	*2.450	*3.600	*3.600	*5.550	*5.550	*6.050	*6.050				
		3,0 m kg	*2.550	*2.550	*4.950	3.900	*6.350	5.400	*8.250	*8.250				
		1,5 m kg	*2.700	*2.700	*5.450	3.750	*6.800	5.250	*9.300	8.100				
		0,0 m kg	*3.050	*3.050	5.250	3.700	*6.950	5.050	*9.550	7.800	*5.600	*5.600		
		- 1,5 m kg	*3.600	*3.600	*4.150	3.650	*6.500	4.950	*8.750	7.700	*8.950	*8.950		
		- 3,0 m kg	*4.250	*4.200			*5.200	5.000	*7.150	*7.150	*9.450	*9.450		
		- 4,5 m kg												
	2,9 m	7,5 m kg	*2.350	*2.350			*3.000	*3.000						
		6,0 m kg	*2.150	*2.150			*4.100	*4.100						
		4,5 m kg	*2.100	*2.100	*3.700	*3.700	*4.900	*4.900	*5.050	*5.050				
		3,0 m kg	*2.150	*2.150	*4.700	3.800	*6.100	5.400	*7.800	*7.800	*12.050	*12.050		
		1,5 m kg	*2.300	*2.300	*5.350	3.750	*6.650	5.200	*9.100	8.100				
		0,0 m kg	*2.600	*2.600	5.250	3.600	*6.850	5.000	*9.450	7.800	*5.750	*5.750		
		- 1,5 m kg	*3.050	*3.050	*4.850	3.600	*6.550	4.950	*8.950	7.650	*8.500	*8.500	*5.100	*5.100
		- 3,0 m kg	*4.050	3.950			*5.500	4.950	*7.550	*7.550	*10.250	*10.250		
		- 4,5 m kg	*4.150	*4.150					*4.800	*4.800				
 <p>Outrigger front + rear</p>	2,25 m	7,5 m kg	*3.350	*3.350					*5.150	*5.150				
		6,0 m kg	*3.000	*3.000			*5.000	*5.000	*5.600	*5.600				
		4,5 m kg	*2.900	*2.900	*2.900	*2.900	*6.050	*6.050	*7.250	*7.250	*8.150	*8.150		
		3,0 m kg	*2.950	*2.950	*5.000	4.800	*6.550	*6.550	*8.600	*8.600				
		1,5 m kg	*3.100	*3.100	*5.500	4.700	*6.950	6.600	*9.550	*9.550				
		0,0 m kg	*3.450	*3.450	*5.300	4.650	*7.000	6.450	*9.450	*9.450				
		- 1,5 m kg	*4.150	*4.150			*6.400	*6.400	*8.600	*8.600	*9.100	*9.100		
		- 3,0 m kg	*4.150	*4.150			*4.700	*4.700	*6.700	*6.700	*8.500	*8.500		
		- 4,5 m kg												
	2,6 m	7,5 m kg	*2.750	*2.750										
		6,0 m kg	*2.550	*2.550			*4.500	*4.500						
		4,5 m kg	*2.450	*2.450	*3.600	*3.600	*5.550	*5.550	*6.050	*6.050				
		3,0 m kg	*2.550	*2.550	*4.950	4.800	*6.350	*6.350	*8.250	*8.250				
		1,5 m kg	*2.700	*2.700	*5.450	4.700	*6.800	6.600	*9.300	*9.300				
		0,0 m kg	*3.050	*3.050	*5.350	4.600	*6.950	6.400	*9.550	*9.550	*5.600	*5.600		
		- 1,5 m kg	*3.600	*3.600	*4.150	*4.150	*6.500	6.300	*8.750	*8.750	*8.950	*8.950		
		- 3,0 m kg	*4.250	*4.250			*5.200	*5.200	*7.150	*7.150	*9.450	*9.450		
		- 4,5 m kg												
	2,9 m	7,5 m kg	*2.350	*2.350			*3.000	*3.000						
		6,0 m kg	*2.150	*2.150			*4.100	*4.100						
		4,5 m kg	*2.100	*2.100	*3.700	*3.700	*4.900	*4.900	*5.050	*5.050				
		3,0 m kg	*2.150	*2.150	*4.700	*4.700	*6.100	*6.100	*7.800	*7.800	*12.050	*12.050		
		1,5 m kg	*2.300	*2.300	*5.350	4.650	*6.650	6.550	*9.100	*9.100				
		0,0 m kg	*2.600	*2.600	*5.350	4.550	*6.850	6.350	*9.450	*9.450	*5.750	*5.750		
		- 1,5 m kg	*3.050	*3.050	*4.850	4.500	*6.550	6.300	*8.950	*8.950	*8.500	*8.500	*5.100	*5.100
		- 3,0 m kg	*4.050	*4.050			*5.500	*5.500	*7.550	*7.550	*10.250	*10.250		
		- 4,5 m kg	*4.150	*4.150					*4.800	*4.800				



- A – Reach from swing center
- B – Bucket hook height
- C – Lifting capacities, including bucket linkage (120 kg) and bucket cylinder (109 kg)

When removing linkage or cylinder, lifting capacities can be increased by their respective weights.

\* Load is limited by hydraulic capacity rather than tipping. Ratings are based on SAE Standard No. J1097. Rated loads do not exceed 87% of hydraulic lift capacity or 75% of tipping load.



-  – Rating over front
-  – Rating over side
-  – Rating at maximum reach

# Lifting Capacity

## Two-piece boom / undercarriage width 2,75 m

Arm length	A	⊗		7,5 m		6,0 m		4,5 m		3,0 m		1,5 m		
		⊙	⊙	⊙	⊙	⊙	⊙	⊙	⊙	⊙	⊙	⊙	⊙	
 <p>Without stabilizer</p>	2,25 m	7,5 m	kg	*3.650	*3.650			*5.450	5.350					
		6,0 m	kg	*3.150	2.700			4.150	3.350	*5.400	5.300			
		4,5 m	kg	2.800	2.250	2.850	2.250	4.050	3.300	6.350	5.050	*6.350	*6.350	
		3,0 m	kg	2.550	2.050	2.800	2.250	3.900	3.100	6.000	4.650			
		1,5 m	kg	2.400	1.950	2.700	2.150	3.650	2.900	5.600	4.350			
		0,0 m	kg	2.550	1.950	2.700	2.100	3.600	2.850	5.400	4.200			
	- 1,5 m	kg	2.750	2.200			3.600	2.800	5.400	4.100	*8.250	7.650		
	- 3,0 m	kg												
	- 4,5 m	kg												
	- 4,5 m	kg												
	2,6 m	7,5 m	kg	*3.000	*3.000									
		6,0 m	kg	*2.700	2.450			4.200	3.350					
		4,5 m	kg	*2.550	2.100	2.850	2.250	4.050	3.300	*5.400	5.100			
		3,0 m	kg	2.400	1.850	2.750	2.200	3.900	3.100	6.000	4.700			
		1,5 m	kg	2.300	1.800	2.700	2.100	3.750	2.900	5.600	4.350			
		0,0 m	kg	2.350	1.850	2.650	2.050	3.600	2.800	5.400	4.100			
	- 1,5 m	kg	2.550	2.000	2.600	2.050	3.350	2.750	5.300	4.050	*8.150	7.450		
	- 3,0 m	kg	3.250	2.550			3.550	2.800	5.350	4.100				
- 4,5 m	kg													
2,9 m	7,5 m	kg	*2.550	*2.550			*3.450	3.300						
	6,0 m	kg	*2.300	2.250			4.150	3.350						
	4,5 m	kg	*2.200	1.900	2.800		4.050	3.250	*4.550	*4.550				
	3,0 m	kg	2.200		2.700	2.150	3.900	3.050	6.000	4.750				
	1,5 m	kg	2.100	1.650	2.650	2.100	3.700		5.600					
	0,0 m	kg	2.150	1.650	2.550		3.550	2.750	5.350	4.100	*4.900	*4.900		
- 1,5 m	kg	2.350	1.800	2.500	1.950	3.450		5.250		*7.700	7.400			
- 3,0 m	kg	2.850				3.450		5.250						
- 4,5 m	kg													
 <p>Front or rear blade</p>	2,25 m	7,5 m	kg	*3.650	*3.650			*5.450	*5.450					
		6,0 m	kg	*3.150	3.050			*5.200	3.800	*5.400	*5.350			
		4,5 m	kg	*3.000	2.550	*3.350	2.600	*5.600	3.700	*6.500	5.750	*6.350	*6.350	
		3,0 m	kg	*3.000	2.350	*4.750	2.550	*5.950	3.550	*8.250	5.350			
		1,5 m	kg	*3.050	2.250	*4.950	2.500	*6.400	3.400	*9.550	5.000			
		0,0 m	kg	*3.350	2.300	*5.200	2.400	*7.000	3.300	*9.550	4.800			
	- 1,5 m	kg	*3.850	2.550			*6.400	3.250	*8.700	4.800	*8.250	*8.250		
	- 3,0 m	kg												
	- 4,5 m	kg												
	2,6 m	7,5 m	kg	*3.000	*3.000									
		6,0 m	kg	*2.700	*2.650			*4.650	3.800					
		4,5 m	kg	*2.550	2.400	*3.950	2.600	*5.400	3.750	*5.400	*5.400			
		3,0 m	kg	*2.550	2.150	*4.600	2.550	*5.700	3.550	*7.800	5.400			
		1,5 m	kg	*2.650	2.100	*4.800	2.450	*6.200	3.350	*9.300	5.000			
		0,0 m	kg	*2.900	2.150	*5.050	2.400	*6.750	3.250	*9.550	4.800			
	- 1,5 m	kg	*3.350	2.350	*4.600	2.400	*6.600	3.150	*8.950	4.700	*8.150	*8.150		
	- 3,0 m	kg	*4.700	3.000			*5.250	3.200	*7.300	4.800				
	- 4,5 m	kg												
2,9 m	7,5 m	kg	*2.550	*2.550			*3.450	*3.450						
	6,0 m	kg	*2.300	*2.300			*4.150	3.800						
	4,5 m	kg	*2.200	2.200	*3.900	2.550	*4.700	3.700	*4.550	*4.550				
	3,0 m	kg	*2.200	2.000	*4.400	2.500	*5.550	3.500	*7.550	5.400				
	1,5 m	kg	*2.300	1.950	*4.650	2.400	*6.050	3.300	*8.850	5.000				
	0,0 m	kg	*2.450	1.950	*4.900	2.350	*6.600	3.150	*9.550	4.750	*4.900	*4.900		
- 1,5 m	kg	*2.850	2.150	*4.900	2.300	*6.650	3.150	*9.050	4.650	*7.700	*7.700			
- 3,0 m	kg	*4.150	2.550			*5.550	3.150	*7.650	4.700					
- 4,5 m	kg													
 <p>Rear outrigger</p>	2,25 m	7,5 m	kg	*3.650	3.500			*5.450	4.950					
		6,0 m	kg	*3.150	2.400			*5.200	3.000	*5.400	4.750			
		4,5 m	kg	*3.000	2.150	*3.350	2.050	*5.600	3.100	*6.500	4.450	*6.350	*6.350	
		3,0 m	kg	*3.000	1.950	*4.750	2.100	*5.950	2.900	*8.250	4.050			
		1,5 m	kg	*3.050	1.850	*4.950	2.050	*6.400	2.700	*9.550	3.850			
		0,0 m	kg	*3.350	1.900	4.950	1.950	*7.000	2.650	*9.550	3.850			
	- 1,5 m	kg	*3.850	1.950			*6.400	2.650	*8.700	3.600	*8.250	6.350		
	- 3,0 m	kg												
	- 4,5 m	kg												
	2,6 m	7,5 m	kg	*3.000	*3.000									
		6,0 m	kg	*2.700	2.250			*4.650	3.150					
		4,5 m	kg	*2.550	1.900	*3.950	2.050	*5.400	3.000	*5.400	4.500			
		3,0 m	kg	*2.550	1.650	*4.600	2.100	*5.700	2.750	*7.800	4.050			
		1,5 m	kg	*2.650	1.700	*4.800	2.050	*6.200	2.650	*9.300	3.900			
		0,0 m	kg	*2.900	1.650	*5.050	1.800	*6.750	2.550	*9.550	3.750			
	- 1,5 m	kg	*3.350	1.850	*4.600	1.950	*6.600	2.450	*8.950	3.700	*8.150	6.450		
	- 3,0 m	kg	*4.700	2.250			*5.250	2.500	*7.300	3.600				
	- 4,5 m	kg												
2,9 m	7,5 m	kg	*2.550	*2.550			*3.450	3.100						
	6,0 m	kg	*2.300	2.100			*4.150	3.000						
	4,5 m	kg	*2.200	1.850	*3.900	2.100	*4.700	2.850	*4.550	*4.550				
	3,0 m	kg	*2.200	1.550	*4.400	2.050	*5.550	2.750	*7.550	4.200				
	1,5 m	kg	*2.300	1.600	*4.650	1.950	*6.050	2.550	*8.850	3.800				
	0,0 m	kg	*2.450	1.650	*4.900	1.900	*6.600	2.550	*9.550	3.550	*4.900	*4.900		
- 1,5 m	kg	*2.850	1.700	4.900	1.850	*6.650	2.450	*9.050	3.400	*7.700	6.300			
- 3,0 m	kg	*4.150	2.100			*5.550	2.550	*7.650	3.500					
- 4,5 m	kg													

PW180-11

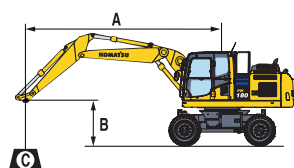

Arm length	A	⊗		7,5 m		6,0 m		4,5 m		3,0 m		1,5 m		
		⊗	⊗	⊗	⊗	⊗	⊗	⊗	⊗	⊗	⊗	⊗	⊗	
 <p>Outrigger + blade</p>	2,25 m	7,5 m kg	*3.650	*3.650					*5.450	*5.450				
		6,0 m kg	*3.150	*3.150			*5.200	*5.200	*5.400	*5.400				
		4,5 m kg	*3.000	*3.000	*3.350	*3.350	*5.600	*5.600	*6.500	*6.500	*6.350	*6.350		
		3,0 m kg	*3.000	*3.000	*4.750	3.900	*5.950	5.450	*8.250	*8.250				
		1,5 m kg	*3.050	*3.050	*4.950	3.850	*6.400	5.300	*9.550	8.150				
		0,0 m kg	*3.350	*3.350	*5.200	3.800	*7.000	5.150	*9.550	7.950				
	- 1,5 m kg	*3.850	*3.850			*6.400	5.100	*8.700	7.950	*8.250	*8.250			
	- 3,0 m kg													
	- 4,5 m kg													
	2,6 m	7,5 m kg	*3.000	*3.000										
		6,0 m kg	*2.700	*2.700			*4.650	*4.650						
		4,5 m kg	*2.550	*2.550	*3.950	*3.950	*5.400	*5.350	*5.400	*5.400				
3,0 m kg		*2.550	*2.550	*4.600	3.900	*5.700	5.450	*7.800	*7.800					
1,5 m kg		*2.650	*2.650	*4.800	3.800	*6.200	5.250	*9.300	8.150					
0,0 m kg		*2.900	*2.900	*5.050	3.750	*6.750	5.100	*9.550	7.950					
- 1,5 m kg	*3.350	*3.350	*4.600	3.750	*6.600	5.100	*8.950	7.800	*8.150	*8.150				
- 3,0 m kg	*4.700	*4.650			*5.250	5.100	*7.300	*7.200						
- 4,5 m kg														
2,9 m	7,5 m kg	*2.550	*2.550			*3.450	*3.450							
	6,0 m kg	*2.300	*2.300			*4.150	*4.150							
	4,5 m kg	*2.200	*2.200	*3.900	*3.900	*4.700	*4.700	*4.550	*4.550					
	3,0 m kg	*2.200	*2.200	*4.400	3.850	*5.550	5.450	*7.550	*7.550					
	1,5 m kg	*2.300	*2.300	*4.650	3.750	*6.050	5.250	*8.850	8.150					
	0,0 m kg	*2.450	*2.450	*4.900	3.700	*6.600	5.100	*9.550	7.850	*4.900	*4.900			
- 1,5 m kg	*2.850	*2.850	*4.900	3.650	*6.650	5.000	*9.050	7.800	*7.700	*7.700				
- 3,0 m kg	*4.150	4.100			*5.550	5.050	*7.650	*7.650						
- 4,5 m kg														
 <p>Outrigger front + rear</p>	2,25 m	7,5 m kg	*3.650	*3.650					*5.450	*5.450				
		6,0 m kg	*3.150	*3.150			*5.200	*5.200	*5.400	*5.400				
		4,5 m kg	*3.000	*3.000	*3.350	*3.350	*5.600	*5.600	*6.500	*6.500	*6.350	*6.350		
		3,0 m kg	*3.000	*3.000	*4.750	*4.750	*5.950	*5.950	*8.250	*8.250				
		1,5 m kg	*3.050	*3.050	*4.950	4.800	*6.400	*6.400	*9.550	*9.550				
		0,0 m kg	*3.350	*3.350	*5.200	4.700	*7.000	6.550	*9.550	*9.550				
	- 1,5 m kg	*3.850	*3.850			*6.400	*6.400	*8.700	*8.700	*8.250	*8.250			
	- 3,0 m kg													
	- 4,5 m kg													
	2,6 m	7,5 m kg	*3.000	*3.000										
		6,0 m kg	*2.700	*2.700			*4.650	*4.650						
		4,5 m kg	*2.550	*2.550	*3.950	*3.950	*5.400	*5.400	*5.400	*5.400				
3,0 m kg		*2.550	*2.550	*4.600	*4.600	*5.700	*5.700	*7.800	*7.800					
1,5 m kg		*2.650	*2.650	*4.800	4.750	*6.200	*6.200	*9.300	*9.300					
0,0 m kg		*2.900	*2.900	*5.050	4.650	*6.750	6.500	*9.550	*9.550					
- 1,5 m kg	*3.350	*3.350	*4.600	*4.600	*6.600	6.450	*8.950	*8.950	*8.150	*8.150				
- 3,0 m kg	*4.700	*4.700			*5.250	*5.250	*7.300	*7.300						
- 4,5 m kg														
2,9 m	7,5 m kg	*2.550	*2.550			*3.450	*3.450							
	6,0 m kg	*2.300	*2.300			*4.150	*4.150							
	4,5 m kg	*2.200	*2.200	*3.900	*3.900	*4.700	*4.700	*4.550	*4.550					
	3,0 m kg	*2.200	*2.200	*4.400	*4.400	*5.550	*5.550	*7.550	*7.550					
	1,5 m kg	*2.300	*2.300	*4.650	*4.650	*6.050	*6.050	*8.850	*8.850					
	0,0 m kg	*2.450	*2.450	*4.900	4.600	*6.600	6.450	*9.550	*9.550	*4.900	*4.900			
- 1,5 m kg	*2.850	*2.850	*4.900	4.600	*6.650	6.350	*9.050	*9.050	*7.700	*7.700				
- 3,0 m kg	*4.150	*4.150			*5.550	*5.550	*7.650	*7.650						
- 4,5 m kg														



- A – Reach from swing center
- B – Bucket hook height
- C – Lifting capacities, including bucket linkage (120 kg) and bucket cylinder (109 kg)

When removing linkage or cylinder, lifting capacities can be increased by their respective weights.

\* Load is limited by hydraulic capacity rather than tipping. Ratings are based on SAE Standard No. J1097. Rated loads do not exceed 87% of hydraulic lift capacity or 75% of tipping load.

-  – Rating over front
-  – Rating over side
-  – Rating at maximum reach

# Standard and Optional Equipment

## ENGINE

Komatsu SAA6D107E-3 turbocharged common rail direct injection diesel engine	●
EU Stage IV compliant	●
Suction type cooling fan	●
Automatic engine warm-up system	●
Engine overheat prevention system	●
Auto-deceleration function	●
Adjustable idle shutdown	●
Engine ignition can be password secured on request	●
Batteries 2 × 12 V/125 Ah	●

## HYDRAULIC SYSTEM

Electronic closed-centre load sensing (E-CLSS) hydraulic system (HydrauMind)	●
Pump and engine mutual control (PEMC) system	●
6-working mode selection system; power mode, economy mode, breaker mode, attachment power and attachment economy mode, and lifting mode	●
PowerMax function	●
Adjustable PPC wrist control levers for arm, boom, bucket and swing, with sliding proportional control for attachments and 5 auxiliary buttons, with FNR switch	●
Additional hydraulic circuit (HCU-B)	●
Additional hydraulic circuit (HCU-C)	○
Extension HCU-C to HCU-D	○
Komatsu Integrated Attachment Control (KIAC)	○
Boom suspension system (ECSS)	○
Prepared for hydraulic quick-coupler	○

## UNDERCARRIAGE

Parallel blade (front and/or rear) with cylinder protection	○
2 or 4 outriggers with cylinder protection, individually adjustable	○
Twin tyres 10.00-20 16 PR	○
Twin tyres Bandenmarkt Excavator 315/70 R22.5	○
Twin tyres Nokian 10-20 (L5)	○
Single tyres Michelin 18.00-19.5	○
Tyres Bandenmarkt Grader 315/70 R22.5	○
Trailer hitches	○
Fenders	○

## CABIN

SpaceCab™; Highly pressurised and tightly sealed hyper viscous mounted cab with tinted safety glass windows, large roof window with sun shade, pull-up type front window with locking device, removable lower window, front window wiper with intermittent feature, sun roller blind, cigarette lighter, luggage shelf, floor mat	●
Heated air suspension seat with lumbar support, arm rests and retractable seat belt	●
Automatic climate control system	●
12/24 Volt power supplies	●
Beverage holder and magazine rack	●
Hot and cool box	●
Premium comfort seat	○
CD radio with auxiliary input (MP3 jack)	○
Heated, adjustable, suspended seat	○
Lower wiper	○
Rain visor (not with OPG)	○
Joystick steering system	○

## SAFETY EQUIPMENT

KomVision surround view system	●
Electric horn	●
Overload warning device	●
Lockable fuel cap and covers	●
Audible travel alarm	●
Large handrails, rear-view mirrors	●
Battery main switch	●
Boom safety valves	●
Arm safety valve	●
Adjust cylinder safety valve	●
OPG Level II front guard (FOPS)	○
OPG Level II top guard (FOPS)	○
Audible travel alarm (white noise version)	○

## LIGHTING SYSTEM

Standard halogen working lights package (4 front/4 rear)	●
Advanced halogen working lights package (8 front/4 rear)	○
LED working lights package (10 front/4 rear)	○
Beacon	○

## SERVICE AND MAINTENANCE

Automatic fuel line de-aeration	●
Double element type air cleaner with dust indicator and auto dust evacuator	●
KOMTRAX – Komatsu wireless monitoring system (3G)	●
Multifunction video compatible colour monitor with Equipment Management and Monitoring System (EMMS) and efficiency guidance	●
Toolkit	●
Komatsu CARE™ – a maintenance program for Komatsu customers	●
Centralised greasing system	●
Automatic greasing system	○

## DRIVES AND BRAKES

Fully automatic 3-speed transmission driving through front and rear planetary axles	●
Oscillating front axle (10°) with automatic and manual cylinder locking	●
Cruise control	●
2,55 m wide undercarriage	●
2,75 m wide undercarriage	○
20 or 35 km/h speed limitation	○
Transmission guard	○

## WORK EQUIPMENT

Mono boom	○
Two-piece boom	○
2,25 m; 2,6 m; 2,9 m arms	○
Clamshell grip bar	○
Lehnhoff quick-couplers	○
Lehnhoff buckets	○

## OTHER EQUIPMENT

Standard counterweight	●
Electric refuelling pump with automatic shut off function	●
Single chassis tool box	●
Additional chassis tool box	○
Biodegradable oil for hydraulic system	○
Customised paint	○

Further equipment on request

- standard equipment
- optional equipment

Your Komatsu partner:

# KOMATSU

**Komatsu Europe International N.V.**  
 Mechelsesteenweg 586  
 B-1800 VILVOORDE (BELGIUM)  
 Tel. +32-2-255 24 11  
 Fax +32-2-252 19 81  
[www.komatsu.eu](http://www.komatsu.eu)

VENSS06600 10/2018

**KOMATSU** is a trademark of Komatsu Ltd. Japan.

PW180-11